

# Medfusion® Syringe Pump Model 3500

## Operator's Manual

Software Version 6

*This manual and its contents are valid for use with software Version 6 (V6)*

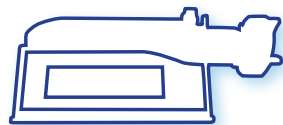

## **Technical Assistance**

The issue date of this manual is included on the back cover. If your manual is a year or more old, contact Smiths Medical to see if a newer manual is available.

If you have comments or questions concerning the operation of the Medfusion® Syringe Pump Model 3500 Version 6 (Medfusion® Model 3500 pump V6), please call the appropriate number given below. When calling, please specify the pump's software version. This information is located on the start-up screen.

Our staff at Smiths Medical in the USA is available to help clinicians 24 hours a day with the programming and operation of the Medfusion® Model 3500 pump V6.

### **Smiths Medical ASD, Inc.**

1265 Grey Fox Road

St. Paul, MN 55112 USA

1 800.258.5361 (USA), +1 214.618.0218

[www.smiths-medical.com](http://www.smiths-medical.com)

A printed copy of this manual is available upon request.

## Table of Contents

<b>Important Safety Information</b>	<b>1</b>	Continuous mode: mL/hr.....	37
Warnings.....	1	Dose / Min and Dose / Hr.....	38
Cautions.....	3	Dose / Day.....	40
Symbols.....	4	Dose / Time.....	42
<b>Introduction</b>	<b>5</b>	Body weight/surface area infusion deliveries.....	44
Indications for use.....	5	Volume / weight infusions.....	46
Contraindications.....	6	Dose/kg/time (dose/m <sup>2</sup> /time).....	48
<b>About the pump</b>	<b>7</b>	Volume / weight / time.....	50
Features and Controls.....	7	Volume / time.....	52
Keypad closeup.....	8	Intermittent volume / time.....	53
<b>Pump Customization and General</b>		Recall last settings.....	55
<b>Programming</b>	<b>10</b>	Priming the system.....	57
Custom Configuration.....	10	<b>Options</b>	<b>59</b>
General Programming.....	12	Bolus dosing.....	60
Exceeding limits.....	12	Bolus programming.....	60
How pump settings and limits are prioritized.....	12	Bolus delivery.....	62
User defined pump Configurations.....	13	Continuing an interrupted bolus dose.....	63
What are Configurations?.....	13	Bolus dose rate reduction.....	64
When are Drug Programs used?.....	13	Loading doses.....	66
Who can use these Drug Programs?.....	13	Set up loading dose.....	66
Types of programmable Library Categories.....	13	Delivering a loading dose.....	68
Using a Custom Configuration.....	14	Continuing an interrupted loading dose.....	69
Using Quick Libraries.....	15	Loading dose rate reduction.....	70
PharmGuard® Safety Software: Dose Protocol		Volume limit.....	72
Protection.....	17	Setting volume limit.....	72
Soft limits.....	17	Keep Vein Open (KVO) rate.....	74
Hard limits.....	17	Programming KVO rate.....	74
Adjusted limits in reverse.....	18	Standby.....	76
Overridden limits in reverse.....	18	Programming standby.....	76
Invalid infusion parameter combination.....	18	Delayed start.....	78
PharmGuard® Supported Syringes (PSS) Series 2.....	19	Programming delayed start.....	78
Navigating the pump menus.....	20	Periodic callback alarm.....	79
The Workflow Process.....	20	Programming periodic callback alarm.....	79
<b>Guidelines for enhanced pump performance</b>	<b>22</b>	Override and toggle features.....	81
Always use the smallest syringe for volume of fluid		Change to Dose / Change to Volume.....	81
being delivered.....	22	Override occlusion limit.....	82
Bolus Volume.....	23	Override alarm loudness.....	83
Use appropriate internal diameter tubing.....	23	Disable/enable FlowSentry™ pressure monitoring.....	84
<b>Programming an Infusion</b>	<b>24</b>	Disable/enable near empty alarm tone.....	84
Turn the pump on.....	24	Disable/enable vol empty alarm tone.....	85
Turning the pump off.....	25	<b>Infusion Delivery</b>	<b>86</b>
Selecting a Delivery Mode and Programming an		Starting & stopping infusion delivery.....	86
infusion.....	26	Start delivery from pause.....	86
General Infusion Programming Procedure.....	27	Starting delivery from standby or delayed start.....	87
Selecting an Infusion.....	28	Stopping delivery.....	87
Select a Profile (Custom Configuration).....	29	Continuing interrupted delivery.....	87
Select a Category.....	30	Flush feature.....	88
Select a Drug Program.....	30	Volume only.....	88
Select a Delivery Mode (Medfusion® Standard		Continuing an interrupted flush infusion.....	89
Configuration).....	31	Volume and time.....	90
Loading a syringe and syringe model setup.....	32	Time to occlusion.....	92
Unloading the syringe.....	36	Occlusion trend graph during delivery.....	92
Programming Infusions.....	37	FlowSentry™ pressure monitoring (rapid occlusion	
		detection).....	92
		Post occlusion bolus reduction.....	93
		Making changes during delivery.....	94
		Changing delivery rate.....	94

Changing rate during delivery ..... 94  
 Changing the rate when paused..... 95  
 Total volume, program volume / dose delivered..... 96  
 Displaying “Program Volume Delivered” (PVD) /  
 “Program Dose Delivered” (PDD) ..... 96  
 Clearing total volume, program volume, or program  
 dose delivered ..... 97  
 Keypad lock ..... 98

**Alarms & remedies 99**

Alarms / alerts types..... 99  
 Re-displaying an alarm message..... 100  
 “User Callback” alarm ..... 101  
 Syringe Empty Alarm Process ..... 101  
 “Syringe Near Empty” alarm ..... 101  
 “Syringe Volume Near Empty” alarm ..... 101  
 “Syringe Empty” alarm ..... 102  
 System Advisory - Maintenance is Recommended ..... 102  
 System Failures ..... 102  
 General system alarms & alerts ..... 103  
 System Failure and Advisory Alarms..... 107  
 Battery Alarms ..... 107  
 System Failure Alarms ..... 108  
 System Advisory Alarms..... 108

**Battery and AC power operation 110**

On screen display of internal battery power level  
 gauge..... 111  
 Battery guidelines ..... 111

**Poleclamp use 112**

Rotating/detachable poleclamp (standard)..... 112  
 Assembling the rotating/detachable poleclamp..... 113  
 EMC information for the Medfusion® Model 3500  
 pump V6 ..... 114  
 Use of cables ..... 114  
 Stacked equipment ..... 114

**Technical specifications & other information 115**

Pump development standards ..... 115  
 Medical Electrical Equipment Safety ..... 115  
 Electromagnetic Compatibility..... 115  
 Miscellaneous Standards..... 116  
 Compliance using: ..... 118  
 Technical specifications ..... 122  
 Specifications..... 122

**Safety Features 126**

Safety Features and Fault Detection..... 126  
 Hardware Safety Features..... 126  
 Software Safety Features ..... 126  
 Hardware-related Software Safety Features ..... 126  
 Program Memory - Check FLASH memory  
 POST or BGND..... 126  
 RAM Memory Check - RAM BGND ..... 126  
 Motor Circuit Check - pump motor phase A or B  
 POST and Motor rate error during operation... 126  
 Keyboard Encoder Check - Control key POST or  
 BGND ..... 126  
 Data Handling Software Safety Features ..... 126

Data Stored in EEPROM - Critical data POST or  
 EEPROM timeout or Primary/Secondary  
 critical data corrupted ..... 126  
 Data Used in Calculations - Critical data failure .. 126  
 Timer Data Registers - Time base BGND, time  
 of day clock POST, time of day clock timeout... 127

**Additional Technical Information 128**

Medfusion® Standard Syringes..... 128  
 PharmGuard® Supported Syringes (PSS) Series 2 ..... 128  
 Flow rate & minimum volume by manufacturer &  
 size - Standard syringes..... 129  
 Concentration and dosing units ..... 131  
 PharmGuard® software limits ..... 131  
 Configuration options..... 132  
 General Options..... 132  
 Auto Prompt Options..... 134  
 Program Options ..... 135  
 Device Setup Features ..... 136  
 Flow Delivery Graphs ..... 136  
 Start-up curves over stabilization period..... 137  
 Trumpet curves over T2 period ..... 137  
 Magnetic Resonance Imaging (MRI) Information ..... 138  
 MRI Related Testing..... 138  
 Image Distortion..... 138  
 Cleaning and care ..... 139  
 Maintenance & service ..... 140  
 Periodic maintenance..... 140  
 Using Smiths Medical USA service assistance..... 141  
 Returning a pump to the USA for repair..... 142  
 Collect Separately ..... 143

**Limited Warranty 144**

**Index 145**

## Important Safety Information

**WARNING: Read this entire manual before using the Medfusion® Model 3500 pump V6. Failure to follow the instructions and important information contained in this manual, or improper/inadequate troubleshooting can lead to death or serious injury. Warnings, cautions and other important safety information can be found in this section, and throughout the manual (they are contained within lines above and below in the main part of the manual). See the Alarms and Remedies section for information on troubleshooting pump alarms.**

The term **WARNING** is used in this manual to indicate a hazard that has the potential to cause injury or death to a patient or user. The term **CAUTION** is used to indicate a hazard that has the potential to cause damage to the product or other property.

### Warnings

- To avoid risk of explosion, never use the pump in the presence of flammable anesthetics, oxygen-enriched atmospheres, or explosive gases.
- Due to risk of explosion, never use this pump inside a hyperbaric chamber. If the patient is placed in a hyperbaric chamber while connected to a pump located outside the chamber, delivery accuracy can be affected. Due to pressure changes on the IV tubing, under-delivery can occur during compression, and over-delivery can occur during decompression.
- Medical Electrical Equipment needs special precautions regarding EMC and needs to be installed and put into service according to the EMC information provided.
- Portable and mobile Radio Frequency (RF) communications equipment can affect medical electrical equipment.
- This equipment/system is intended for use by healthcare professionals only.
- The unauthorized modification of this product may constitute a safety hazard, which could lead to patient injury or death, as well as the potential for property damage (including the risk of fire). Use only Smiths Medical supplied service/replacement parts, including the battery pack. Unauthorized modification and/or the use of unauthorized service/replacement parts will also void the Limited Warranty.
- Before using any Medfusion® Model 3500 pump V6, users must be thoroughly familiar with the contents of the operator's manual, including all warnings, cautions, and instructions for use.
- The user should ensure that the performance offered by the pump is fit for the intended use and that the pump is not used in any way or for any purpose other than its intended purpose.
- This pump is not to be used in any intra-articular space infusion.
- If the pump is used to deliver life-sustaining medications, an additional pump must be available for situations where an interruption in infusion could be dangerous.
- Do not use on the inlet side of *Extracorporeal Membrane Oxygenation* (ECMO) systems where the negative pressure is greater than negative 100mm Hg as the high negative pressures can result in uncontrolled fluid flow.
- The pump must be positioned in an MR environment such that it is **secured to a non-moveable object** and the magnetic fringe field **does not exceed 150 gauss**. Exposing the Medfusion® Model 3500 pump V6 to magnetic fields that exceed 150 gauss presents a risk of becoming a projectile hazard and can lead to possible patient injury or death. Irreversible damage to the pump can also occur, rendering it inoperable.
- Confirm All Settings.** Before starting **any** delivery, **always** confirm the accuracy of **all** infusion values to the original order. Programming the pump at a delivery rate other than that prescribed will cause inappropriate delivery.
- Always read manufacturer precautions and guidelines for medications, fluids, syringes and administration sets used with this pump. Medications or fluids may interact with the plastic components of the infusion syringe and sets.
- Only use the Medfusion® Standard Syringes Series 2 (supplied with PharmGuard® Toolbox 2, Version 3, and included in the Medfusion® Standard Configuration), or the models and sizes available as part of the PharmGuard® Supported Syringes



(PSS) Series 2, and always confirm that the syringe model and size displayed on the pump matches the model and size loaded onto the pump. Use of unapproved syringes may cause improper pump operation resulting in inaccurate fluid delivery or occlusion sensing or other potential hazards.

- Verify that the plunger holders securely capture the syringe plunger. Make sure to capture the syringe barrel and flange. Failure to properly secure the syringe could result in uncontrolled fluid flow to the patient.
  - Always use the **PRIME** function on the pump when loading a new syringe in order to remove any mechanical slack. Failure to prime correctly can delay infusion delivery and cause *Total Volume Delivered* to read higher than the amount actually delivered to the patient.
  - Periodically check the fluid pathway and all connections (including the catheter/administration set connection) for leaks. Leaks in the system may cause fluid loss resulting in under-delivery, as well as allowing an opening for contamination.
  - Always turn off fluid flow to patient in tubing via clamp or stopcock before loading or unloading a syringe. Uncontrolled fluid flow can occur when infusion set is not clamped or turned off resulting in inappropriate delivery rate.
  - **NEVER** prime any syringe while connected to a patient infusion site, as this may cause over-infusion.
  - To avoid air embolism, always purge all air from syringe and infusion lines *before* connecting to the patient.
  - Once the syringe and tubing system is connected to the patient, raising the system above the patient (even briefly) can cause significant bolusing due to changes in hydrostatic pressure. Lowering the system below the patient (even briefly) can cause significant interruptions in flow due to changes in hydrostatic pressure. This could cause improper pump operation resulting in inaccurate fluid delivery. Place the pump as close to the patient's infusion site as possible.
  - Use the smallest syringe size necessary to deliver the fluid or medication. Using a large syringe at very low rates (below Minimum Recommended Rate for the syringe) may cause improper pump operation, delayed occlusion sensing, larger post occlusion bolus at higher occlusion limit settings, delivery inaccuracies, or other potential hazards.
- Bolus Volume:** Delivering a bolus volume less than the recommended bolus volume for the syringe used may result in delivery inaccuracies. Use an infusion set with the smallest diameter tubing available that does not result in excessive back pressure at the desired flow rate. Consider priming, loading, bolus, and flush rates when selecting an infusion set.
- Larger size syringes at occlusion setting HIGH may produce a post occlusion bolus larger than 0.3 mL due to excessive syringe plunger tip compliance.
  - When using Quick libraries, preset values are automatically inserted without pausing to verify each setting. The **BEGIN INFUSION** screen displays immediately after selecting/confirming the drug program. Verify the infusion parameters before starting the delivery. Certain data fields may not be programmed (e.g. patient weight) and require data entry before the infusion will proceed.
  - If a system failure alarm occurs and cannot be cleared by powering the pump down then back up, the pump cannot be used. Remove it from use and send it to a trained biomedical technician for service.
  - Any external power source connected to the DC jack must be **IEC 60601-1 certified** for medical equipment **Type CF** and meet **Safety Class II** requirements. Connecting any external power source to the Medfusion® Model 3500 pump V6 creates a medical device system. Therefore, the user is responsible for compliance with **IEC 60601-1** standards (see Technical Specifications section for DC power requirements).
  - **Electric Shock hazard.** The only means of removing AC power is to disconnect the AC power cord. While the AC power cord is attached to the pump and plugged into an AC outlet, live mains voltage is present inside the pump.
  - Ensure that the  $\pm 2\%$  accuracy specification ( $\pm$  syringe accuracy) is taken into account when programming the pump and/or filling a syringe. If accuracy is of prime concern, use only syringes that meet the  $\pm 2\%$  requirement of the ISO 7886-2 Standard. Failure to do so may result in medication

in the syringe becoming depleted sooner or later than expected.

- Use of cables other than as listed and with equipment other than those specified may result in increased EMC emissions or decreased immunity of the pump.
- The pump should not be used adjacent to or stacked with other equipment. If adjacent or stacked use is necessary, the user should verify normal operation of the pump in the configuration in which it is to be used.
- To avoid electric shock, before cleaning, always switch electrically operated equipment off and disconnect from AC power source.
- To avoid electric shock, only trained biomedical service personnel may service this pump. Service personnel should disconnect the AC power cord before servicing the pump.
- Always maintain this pump following **manufacturer recommended instructions** in the *Technical Service Manual*. Improperly maintained pumps may cause either under-infusion or over-infusion to patient.
- To avoid electric shock, users should never open the pump case or battery compartment for any reason. Service personnel should always disconnect the AC power cord before servicing the pump.
- Never use a dropped or obviously damaged pump. Withdraw it from service until a trained biomedical technician can test it.
- There are potential health hazards associated with improper disposal of batteries, electronics, and contaminated (used) infusion sets and syringes. Dispose of used batteries, infusion sets, syringes, and other used accessories, or a pump that has reached the end of its useful life, in an environmentally safe manner, and according to any regulations that may apply.

## Cautions

- Federal (USA) law restricts this device to sale by or on the order of a physician.
- **ALWAYS** verify that the software version of the pump (displayed on screen during power-up) and *Operator's Manual* are the same. Refer to this manual's front page.
- **NEVER** use sharp objects to depress keypad keys

on the pump. This may damage the pump by rendering keypad keys inoperable.

- This pump is designed to be used in a *horizontal* position. If the pump is operated in any other position (including vertical), there is an increased potential for fluid leaking into the pump. If fluid leakage into a pump is suspected, remove it from use until a trained biomedical technician can test it.
- Always verify the stability of the object to which the pump is mounted (for instance, an IV pole) before using the poleclamp. Failure to verify the stability could cause the object to tip, with the possibility of causing damage to the pump and other equipment. If the poleclamp is not adequately tightened, it could cause the pump to fall.
- **DO NOT USE** cleaning solutions containing: *acetone, ammonia, ammonium chloride* (including Hyamine 1622), *aromatic solvents* (such as paint thinner, toluene, methylbenzene), *chlorinated solvents* (such as methyl ethyl ketone (MEK), trichloroethane), *ether* (such as ethylene glycol monobutyl ether, diethylene glycol butyl ether) or *oxidizing acids* (such as phosphoric acid, sulfuric acid or accelerated hydrogen peroxide).  
Use of the solutions or solvents listed as DO NOT USE could damage plastic parts and cause premature failure or device malfunction.
- **Use only the recommended cleaning/disinfecting agents and method.** Use of cleaning/disinfecting agents and method other than those listed may cause damage to the pump and will void the warranty.
- The pump is “spray resistant” from the top and sides but not “water proof”. **NEVER** spray cleaning or other fluids directly into openings on the bottom of the pump as pump damage may occur.
- The pump is not certified “waterproof”. Never immerse the pump in water or other fluids as this can render the pump inoperable.
- **NEVER** use light oil sprays (e.g., WD40®) to clean or lubricate pump. These oils contain chemicals that can damage the plastic of the pump. No user-added lubrication is necessary.
- **NEVER** sterilize the pump in a steam autoclave or gas sterilizer. Using autoclave or gas sterilization can seriously damage the pump and will void the warranty.

## Symbols

The following is a list of symbols which may appear on the pump (or on its labeling or accessories), as well as certain technical terms, along with an explanation of what they mean.



Caution



Do not reuse



Catalog number



Serial number



Use by



Date of manufacture



Manufacturer



Not made with natural rubber latex



CAUTION: Federal (USA) law restricts this device to sale by or on the order of a physician.



Temperature limitation



Humidity limitation



Atmospheric pressure limitation



Type CF equipment (protection from electric shock)



Collect Separately



Class II Equipment in which protection against electric shock relies on double or reinforced insulation instead of basic insulation. Accessible metal components of pump enclosure use this higher level of insulation instead of safety grounding.



UL Mark for Canada and the United States. Indicates the product was manufactured in accordance with the requirements of UL (Underwriter's Laboratory).



External DC jack connection. Tip (negative sign) is for power ground and ring (positive sign) is for positive power connection.



Symbol for infrared serial communications port on pump

V ~

Operating voltage range for alternating current (i.e. AC or mains) power source

IPX3

Equipment that is ingress protected from fluid spraying at a vertical angle from above, and from angles to 60° on either side of vertical



Non-ionizing radiation



MR (Magnetic Resonance) Conditional



Pins of connectors and other areas identified with this ESD Warning symbol should not be touched. Connections should only be made when ESD precautionary measures are used.

For an explanation of the symbols that appear on the pump keypad, see “Keypad Closeup” and the tables that follow (page 8).



## Introduction

---

---

**CAUTION: ALWAYS** verify that the software version of the pump (displayed on screen during power-up) and *Operator's Manual* are the same. Refer to this manual's front page.

---

---

The Medfusion® Model 3500 pump V6 is a small, lightweight and portable syringe infusion pump. The pump offers a variety of delivery modes programmable to meet specific patient care needs. The actual modes available on a given pump, and their location on a given screen, depend on the custom setup. Fluids can be delivered from a variety of syringe sizes (1-60 mL) and syringe manufacturers in various delivery modes.

The Medfusion® Model 3500 pump V6 is equipped with PharmGuard® Medication Safety Software, an intuitive system designed to enhance safety while maintaining simplicity, which can allow streamlined implementation and improved work flow.

A pump *Configuration* is created on a PC using the PharmGuard® Toolbox 2, Version 3 software (PharmGuard® Toolbox 2), and then the Configuration is sent to the pump. The Configuration may contain global settings, Profile definitions, library definitions, Drug Programs and syringe definitions (see page 13 for discussion about libraries).

The Medfusion® Model 3500 pump V6 imports and exports data to assist in history data management. The pump communicates via the IR port on the rear of the pump. Pump Configurations and firmware can be updated, and infusion settings and events history downloaded in combination with the PharmGuard® Toolbox 2 software application.

The pump also has the FlowSentry™ pressure monitor (rapid occlusion detection) feature, which is a comprehensive array of pressure-related safety features, including rapid alarm response and reduced false alarms. Pressure trending is shown in the pump display, allowing earlier opportunities for intervention, as well as a post-occlusion bolus reduction feature.

## Indications for use

The Medfusion® Model 3500 pump V6 is indicated for the following uses:

- In the administration of fluids requiring precisely controlled infusion rates including blood or blood products, lipids, drugs, antibiotics, enteral solutions and other therapeutic fluids.
- By the following delivery routes: arterial, epidural, intravenous, intrathecal, subcutaneous and enteral.
- By the following delivery modes: continuous, volume/time, mass, body surface area, body weight, intermittent and bolus.
- In critical care, anesthesia, neonatal and pediatric applications or other healthcare settings where the use of the syringe infusion pump can be monitored or supervised by a clinician.
- Inside the MRI room mounted outside the 150 Gauss line and with shielded magnets of field strength of 1.5 Tesla.

---

---

### WARNINGS:

- This equipment/system is intended for use by healthcare professionals only.
  - Before using any Medfusion® Model 3500 pump V6, users must be thoroughly familiar with the contents of the operator's manual, including all warnings, cautions, and instructions for use.
  - The user should ensure that the performance offered by the pump is fit for the intended use and that the pump is not used in any way or for any purpose other than its intended purpose.
  - This pump is not to be used in any intra-articular space infusion.
  - If the pump is used to deliver life-sustaining medications, an additional pump must be available for situations where an interruption in infusion could be dangerous.
  - The pump must be positioned in an MR environment such that it is ***secured to a non-moveable object*** and the magnetic fringe field ***does not exceed 150 gauss***. Exposing the Medfusion® Model 3500 pump to magnetic fields that exceed 150 gauss presents a risk of becoming a projectile hazard and can lead to possible patient injury or death. Irreversible damage to the pump can also occur, rendering it inoperable.
- 
-

---

**CAUTION: NEVER** use sharp objects to depress keypad keys on the pump. This may damage the pump by rendering keypad keys inoperable.

---

- Only the Medfusion® Standard Syringes Series 2 (supplied with PharmGuard® Toolbox 2, and included in the Medfusion® Standard Configuration), or the additional syringe models and sizes available as part of the PharmGuard® Supported Syringes (PSS) Series 2 (see page 19), may be used on the pump.
- Ensure all medications or fluids are compatible with the syringe, catheters, tubing, and fittings used in the infusion setup.
- Always ensure fluids are compatible with each other when infusing more than one fluid or medication through the same infusion site. If connecting more than one pump to the same infusion site, use one-way checkvalves to prevent pumps from interfering with each other. Verify that the pumps will operate together without alarming.

---

## Contraindications

---

**WARNING: ECMO use:** Do not use on the inlet side of *Extracorporeal Membrane Oxygenation* (ECMO) systems where the negative pressure is greater than negative 100mm Hg as the high negative pressures can result in uncontrolled fluid flow.

---

## About the pump

### Features and Controls

Following are several illustrations showing the various controls, connectors and features of the Medfusion® Model 3500 pump V6.

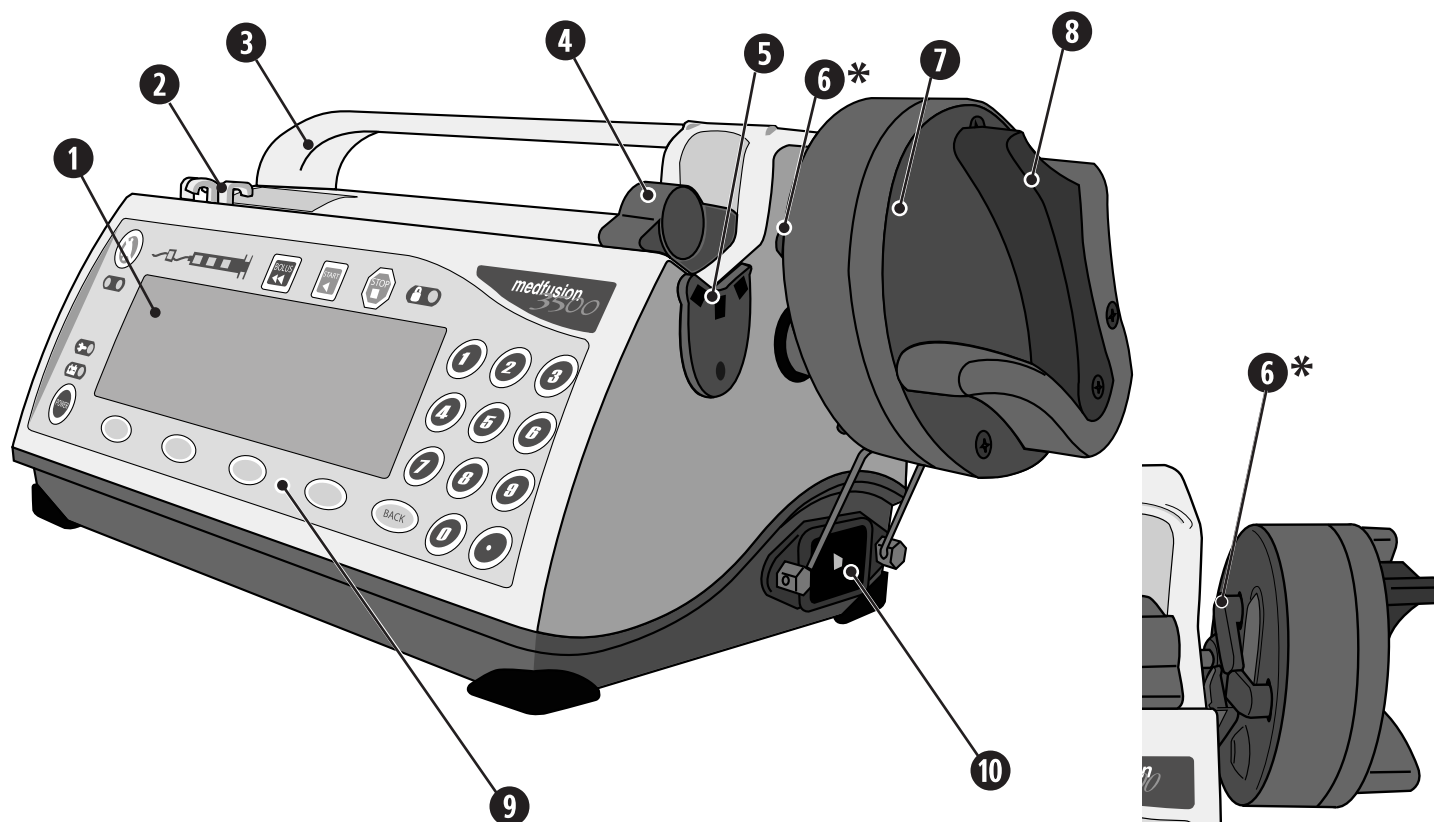



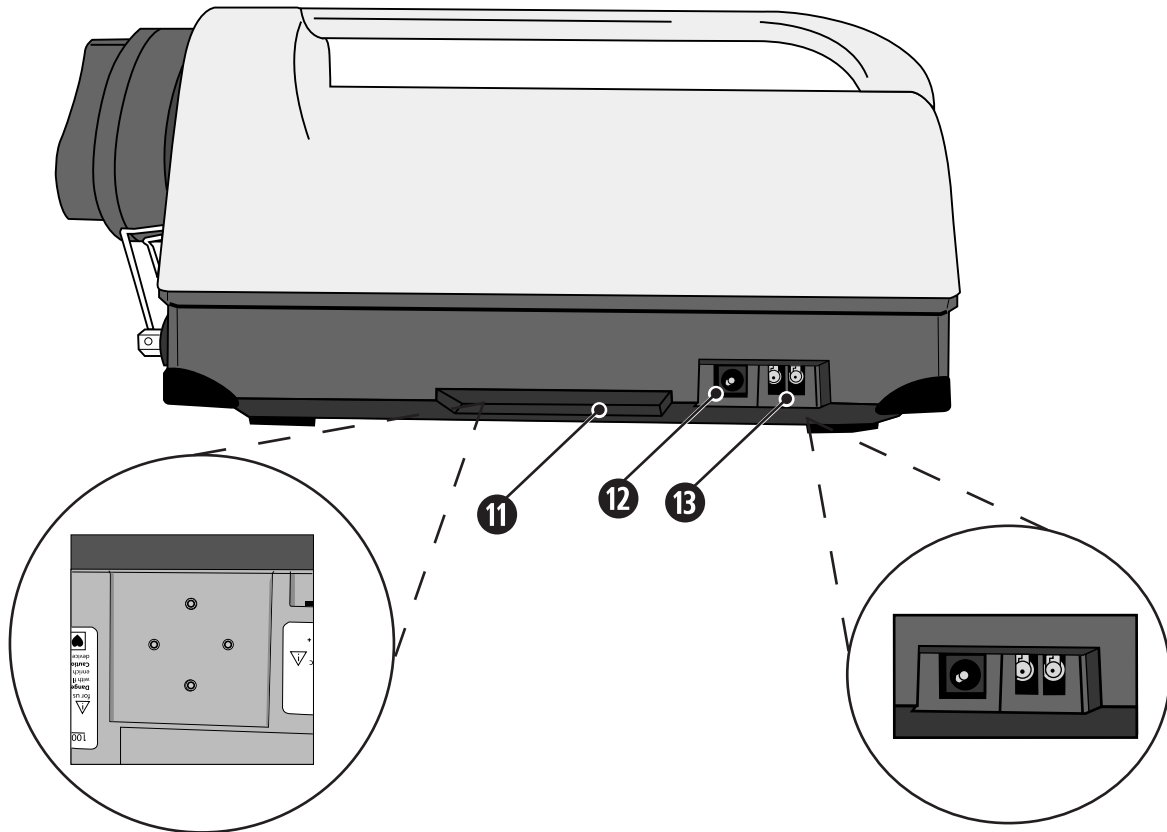



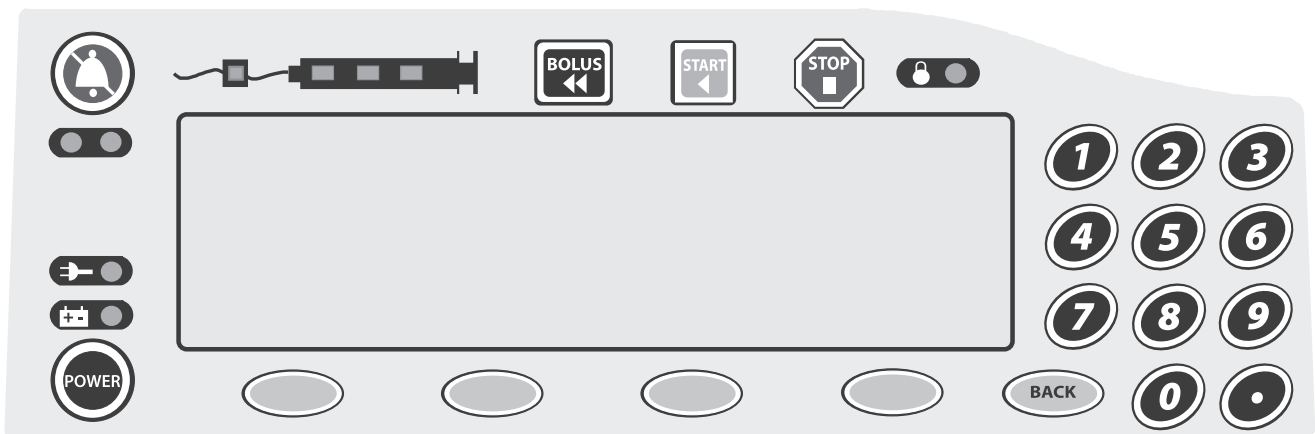

- 1 *Display:* pump operating and status information appears on the display. The lower portion of the display corresponds with the 4 'softkeys' (their function changes depending on the pump programming being accomplished) on the keypad.
- 2 *Tubing Holders:* Thread infusion set tubing between holders to prevent kinking at syringe tip.
- 3 *Carrying Handle*
- 4 *Syringe Barrel Clamp:* The clamp holds the syringe barrel securely in place.
- 5 *Syringe Barrel Flange Clip:* When loading a syringe, slide the syringe flange into the clip.
- 6 *Syringe Plunger Holders:* Holds the syringe plunger securely in place.
- 7 *Syringe Plunger Driver:* Once loaded and delivery is started, the driver pushes the plunger forward at a controlled, precise rate to deliver fluid.
- 8 *Syringe Plunger Release Lever:* Squeeze the release lever to allow placement of the syringe plunger onto the holder during loading, or to remove it during unloading.
- 9 *Keypad:* See Keypad closeup (page 8) for identification of the individual keypad keys and what they are used for.
- 10 *AC Power Connection Port:* Plug the AC power cord into connection port to allow pump to operate on AC (mains) power.







- 11 *Optional Poleclamp Mount:* If desired, attach the optional poleclamp here.
- 12 *External DC Power Connector Port:* Plug approved external DC power supply into port.
- 13 *Infrared RS232 Connection Port:* Align RS232 converter box with port to allow upload of data from and download of data to a pump from a PC.

## Keypad closeup



Key	When pump is paused	When pump is delivering
Alarm Silence (  )	Silences audible alarm. Allows operator to switch the display backlight from bright to dim or dim to bright. Allows redisplay of the text for the last active alarm.	Silences audible alarm. Allows operator to switch the display backlight from bright to dim or dim to bright.
Power (  )	Silence certain active alarms. Push and hold to turn pump off.	Silence certain active alarms (some alarms must be silenced with  before  will function). Push and release, then push and hold to turn pump off.
Menu keys (softkeys)	Function is defined on the display.	Function is defined on the display.
Back (  )	Reverts to a previous step or level.	Reverts to a previous step or level if adjusting settings. Briefly displays the battery life indicator and PDD/PVD.
Numbers & Decimal	Set number values or selects menu items.	Set number values or selects menu items.
Stop (  )	N/A	Stops delivery (pump remains on).
Start (  )	Starts delivery.	N/A
Prime / Bolus (  )	Begins priming after confirmation.	Displays the programmed bolus programming or confirmation/ <b>BEGIN DELIVERY</b> screen.

Indicator	What it means
 - Alarm	The <b>Alarm</b> indicators (yellow or red) are on whenever the pump is in an alarm condition. The specific details of each alarm are covered in the Alarm section later in this manual.
 - AC Line	The <b>AC Line</b> indicator (green) is on whenever the pump is connected to “mains” line power. It is off when the pump is not connected to an active AC line.
 - Battery	The <b>Battery</b> indicator (green) blinks on & off whenever the pump is operating on internal battery power, and remains on when battery is charging.
 - Lock	The <b>Lock</b> indicator indicates the pump has been locked into its current operational mode.  While this indicator is lit, the keypad is locked and no changes can be made to settings. Attempting to stop or change an infusion while locked will result in an alarm and an informational message.
 - Infusing	The <b>Infusing</b> indicators are 3 green lights, which illuminate in sequence right to left when the pump is infusing.  During intermittent volume over time delivery mode, a single Infusing indicator lights during the time between infusions.  When the pump is off or stopped, the Infusing indicator is not lit.



# Pump Customization and General Programming

## Custom Configuration

Generally speaking, pump customization is performed before a pump is used on a patient (see the diagram on page 11).

Customization is accomplished using PharmGuard® Toolbox 2. Once the custom Configuration is created and validated, PharmGuard® Toolbox 2 is used to send it to the pump. Depending on the settings and features chosen in customization, certain features may or may not be available when programming any specific pump. Each user is responsible to determine which features are present on the pump they are using and to program them accordingly.

For this reason, the following warning is included throughout the steps for programming and delivering fluids throughout this manual:

---

---

**WARNING: *Confirm All Settings.*** Before starting *any* delivery, *always* confirm the accuracy of *all* infusion values to the original order. Programming the pump at a delivery rate other than that prescribed will cause inappropriate delivery, which can result in serious injury or death.

---

---

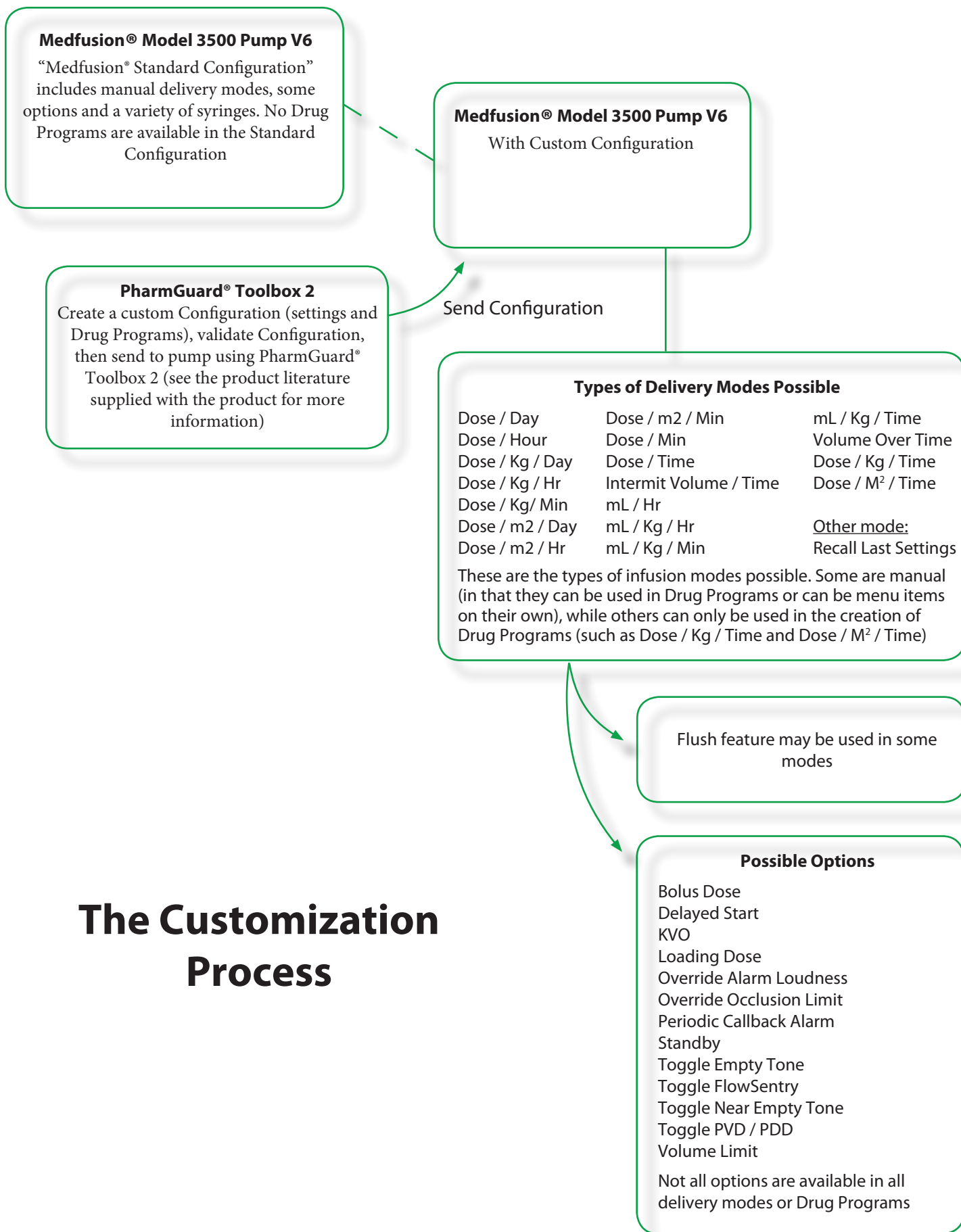

## The Customization Process

## General Programming

The Medfusion® Model 3500 pump V6 has a variety of delivery modes that are customizable by the user. The actual modes available on a given pump, and their location on a given screen, depend on the custom setup performed.

All customization is accomplished using the PharmGuard® Toolbox 2 software, including which syringes and features are available on the pump, as well as hard and soft limits on values (see below and page 17 for discussion about hard and soft limits).

The modes and programming steps described in this chapter, and the steps given for programming them, are based on *general* setup parameters.

Which of the features and functions are available on a specific pump, and how the screens associated with them appear, depends entirely on how the pump was customized. If the functions and screens on a pump look different than those shown here, it is due to this customization.

It is possible that a pump is customized so that an infusion cannot be programmed without first entering a user ID, or so that certain profiles cannot be accessed without first entering a passcode. If that is the case, a prompt to enter an ID or a passcode is displayed when attempting to program an infusion.

---

**WARNING:** Always read manufacturer precautions and guidelines for medications, fluids, syringes and administration sets used with this pump. Medications or fluids may interact with the plastic components of the infusion syringe and sets. This interaction may result in serious injury or death.

---

## Exceeding limits

The pump has two types of programmed infusion limits, Hard limits and Soft limits.

- **Hard Limits** – *Values that cannot be exceeded under any conditions.* Hard limits show up as Max and Min on the pump. If an attempt is made to exceed a hard limit, a screen similar to the following figure displays.



The pump then prompts entry of a new value.

- **Soft Limits** - *The normal range.* Soft Limits show up as Low and High on the pump. They are the normal upper and lower limits. A value above or below the Low or High limit can be entered (so long as it does not exceed the Min or Max). If the soft limits are exceeded, the pump prompts to first silence an alarm, then confirm or cancel the override condition, as shown in the following screen.

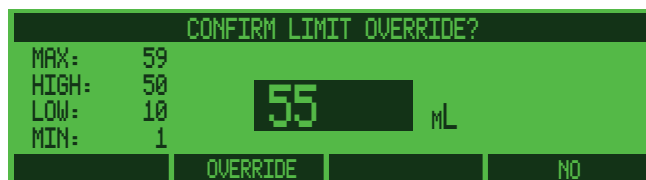

It is possible that a pump is customized so that limits cannot be exceeded unless a user ID is entered. If that is the case, a prompt to enter an ID is displayed.

“Limit” style alerts are advisories that occur for various reasons (usually during programming). A non-repeating audio alarm sounds and a message is displayed for 3 seconds. To re-display the alert message, press . The pump records exceeded limits and attempts to exceed limits.

## How pump settings and limits are prioritized

There can be a number of limits imposed on pump settings, for instance the rate is limited by the syringe size being used, as well as any hard and/or soft limits imposed in the drug program. The most restrictive limit takes priority.

Additionally, available Options for delivery can be set for profiles as well as individual drug programs. In these cases, the settings for the drug program take priority over profile settings. For example, the Bolus option may be enabled for a profile, but a drug program within that profile may have the bolus option disabled.

## User defined pump Configurations

This chapter describes the Medfusion® Model 3500 pump V6 Configuration.

### What are Configurations?

A *Configuration* is a database of pump settings organized into Profiles, Categories and Drug Programs. The Configuration has global settings that are applicable to the pump operations. The Configuration may have up to 16 Profiles. Each Profile has a set of Profile-level settings and also up to 8 Categories. Each Category may contain up to 36 Drug Programs. There is a special category called a Quick Library. A Quick Library contains Drug Programs that have all infusion parameters pre-specified to allow quick start of an infusion. A *Configuration* is defined here as a stored record of infusion settings that load from memory. These *programs* are stored in memory indefinitely (over 10 years) or until overwritten.

The Configuration is set up using PharmGuard® Toolbox 2. When it is completed it should be validated by the person responsible for custom configuration before the pumps are delivered to a work area.

### When are Drug Programs used?

Every unit, department, organization, or hospital has standard ways of delivering medications or fluids. The custom setup enables the use of *programs of stored presets*.

Using the PharmGuard® Toolbox 2 Software, the PharmGuard® Toolbox 2 Administrator will establish the pump Configuration that implements the standard infusions for the unit, department, organization, or hospital. This process is described in the PharmGuard® Toolbox 2 *User's Manual*.

### Who can use these Drug Programs?

Anyone who is authorized to use the infusion pump can use programs from the available libraries.

## Types of programmable Library Categories

There are two types of library categories in the Medfusion® Model 3500 pump V6:

Library Category Type	What it does
<b>Standard</b>	<i>Standard</i> library categories contain programs with parameters that are applied when programming an infusion. These libraries require stepping through and reviewing each setting. This allows modifying standard settings while stepping through preset values.
<b>Quick</b>	A quick category contains drug programs with the presets necessary for programming an infusion. However, they do not pause at each level for entry of the settings. Instead, <i>the entire set of values is programmed at one step including syringe model and size</i> . The <b>BEGIN INFUSION</b> screen, where all infusion values are shown, displays at once. At that point, confirm all the settings are correct, then press  to begin delivery.

### WARNINGS:

**Confirm All Settings.** Before starting *any* delivery, *always* confirm the accuracy of *all* infusion values to the original order. Programming the pump at a delivery rate other than that prescribed will cause inappropriate delivery, which can result in serious injury or death.

When using Quick libraries, preset values are automatically inserted without pausing to verify each setting. The **BEGIN INFUSION** screen displays immediately after selecting/confirming the drug program. Verify the infusion parameters before starting the delivery. Certain data fields may not be programmed (e.g. patient weight) and require data entry before the infusion will proceed.

**Displaying Quick library Options:** The steps in this section are hypothetical. The Medfusion® Model 3500 pump V6 is shipped with a Medfusion® Standard Configuration, and without any Profiles, Categories and Drug Programs. So the actual Quick libraries available depend entirely on the custom Configuration sent to the pump.

## Using a Custom Configuration

PharmGuard® Toolbox 2 allows a facility to create a custom Configuration and send it to the pump for use. If profiles are created in the Configuration, the pump displays the **PROFILE** Menu. If the desired profile isn't displayed on the first screen press **More** for additional selections.

1. If a profile listing isn't displayed on the **SELECT THE PROFILE** menu, press **More** to find it on another screen; otherwise it is necessary to create that profile using PharmGuard® Toolbox 2. For example, if "4" at right is selected, the **GENERAL PEDS** profile opens (profiles names are customized per facility preference, so will not be the same as those shown in the following screens).
2. Library categories in the profile are displayed. Select a category from the menu. For example: if "1" at right is selected, then the drug program category **GEN PEDS A - D** opens.
3. Custom drug programs are displayed on the Drug Program screen. To use a drug program, use the **number** keys to select the desired drug program (see page 30 for a full explanation of this screen).  
*For example:* if entry "2" is selected, the preset infusion parameters for **ABELCET 2 MG/ML** is chosen.
4. You are next prompted to load a syringe, then confirm & accept each level of settings by pressing **Enter**. Some data fields may require data input prior to proceeding (e.g. Patient Weight).

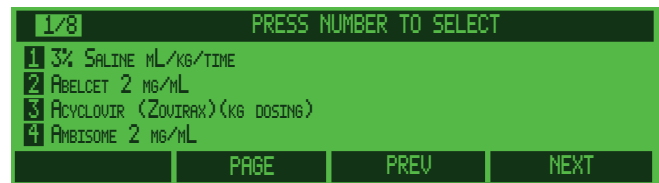
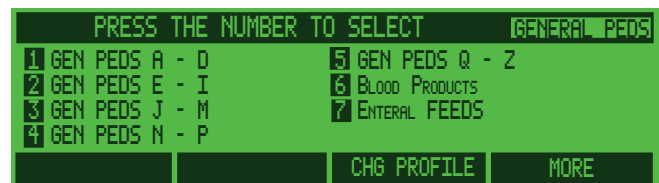
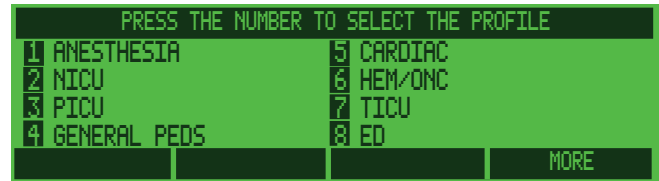

**WARNING: Confirm All Settings.** Before starting *any* delivery, *always* confirm the accuracy of *all* infusion values to the original order. Programming the pump at a delivery rate other than that prescribed will cause inappropriate delivery, which can result in serious injury or death.

5. When all settings are confirmed, the **BEGIN INFUSION** screen is displayed. Use the **Prime** feature, then press  to begin the infusion.



## Using Quick Libraries

Smiths Medical ships the infusion pump with the Medfusion® Standard Configuration that does not include a Quick Library.

The profiles, categories and custom drug programs available on a pump depend on the configuration set up by the person responsible for custom configuration. Quick Libraries is an option that can be set-up in custom configuration. This option designates a category in a profile as a Quick Library.

A profile with Quick Library enabled displays a list of custom drug programs.

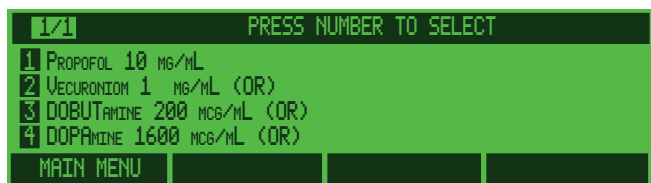

Rather than the **CHG Profile** key displayed on standard library category screens, the Quick Library will have **Main Menu** on the far left. When **Main Menu** is pressed, another selection screen is displayed, with the additional categories and delivery modes for the selected profile.

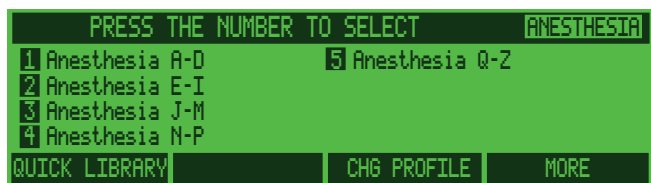

The softkey on the far left of this screen reflects the name of the Quick library (the above is an example only). Press this key to re-enter the Quick library. The Quick library is exited when **Main Menu** is pressed. The **CHG Profile** key responds the same here as with all others.

(If there is only one profile on the pump, and a Quick library is enabled, the drug programs in the designated Quick Library will display on screen after the pump is turned on and completes its self tests.)

The drug programs in a Quick Library have been customized with default values for infusion parameters that may include: syringe model and size, dose, volume, weight, delivery time, etc. Setting default values in the custom program allows the user to proceed from the drug program selection screen to the final confirmation screen (provided the loaded syringe matches the default syringe in the drug program).

The Quick Library program's preset values are loaded automatically into the pump *provided that you have loaded a syringe of the manufacturer and size programmed for this library entry*. Press  to begin the preset infusion after verifying infusion settings and using the **Prime** feature. Some data fields may be blank and require data entry to proceed.

1. To use Quick Library programs from the **SELECT** screen, use the **number** keys to select a drug program.

*For example:* if “1” at right is selected, the pump loads the stored settings for **PROPOFOL 10 MG/ML** infusion and pauses at the **BEGIN INFUSION** screen.

2. All the infusion settings display on the **BEGIN INFUSION** screen. You have the option to change the default settings for weight and dose using the softkeys displayed. All settings should be confirmed to ensure they are correct. Always check the infusion settings’ accuracy. **You are responsible for ensuring the safety of any infusion the pump is programmed to deliver.**
3. Use the **Prime** feature, then press  to begin the infusion.

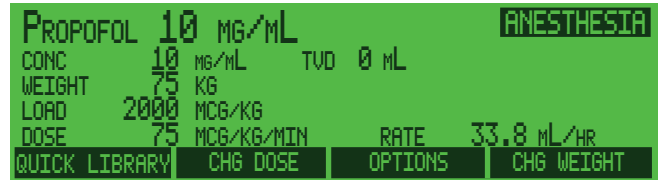
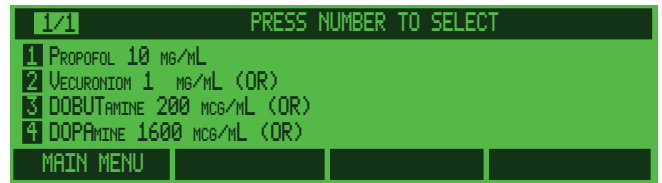

## PharmGuard® Safety Software: Dose Protocol Protection

PharmGuard® Medication Safety Software provides programmable Hard *and* Soft upper and lower limits for infusion parameters. Refer to the PharmGuard® software limits in the Technical Specifications section of this manual (page 131) for a list of all parameters that may be protected with PharmGuard® software limits.

### Soft limits

Soft limits are the normal limits, and show on screen as **High** and **Low**. Soft limits can be exceeded (so long as the Hard limits or the physical limits imposed by the syringe size in use are not exceeded).

1. When attempting to enter or change infusion parameters of a drug program, the soft limits are displayed on screen as “**HIGH**” and “**LOW**”.
2. If a value is entered that is outside the range, an audible alarm sounds and the message “**OUTSIDE RANGE LIMIT – SILENCE ALARM TO CONTINUE**” appears.
3. Once the alarm is silenced, the message “**CONFIRM LIMIT OVERRIDE?**” appears.
4. If **Override** is pressed, the value will be accepted. If **No** is pressed, the value entry screen reappears.

### Hard limits

Hard limits are the absolute maximum and minimum for a value.

When attempting to enter or change a numeric infusion parameter of a drug program the Hard limits are displayed on screen as “**MAX:**” and “**MIN:**” values. It is not possible to exceed a Hard limit.

### Adjusted limits in reverse

During set up, the pump determines absolute minimums and maximums based on the physical abilities of the pump, such as syringe size (among other things). (See the table on page 129 for minimum and maximum flow rates.) If the PharmGuard® software limits are outside of the pump limits, the pump adjusts the limits as appropriate. When this occurs, the limit priority alarm **“LIMITS ADJUSTED—CANNOT DELIVER ALL DOSES”** is sounded. When the pump adjusts limits, they are reverse highlighted.

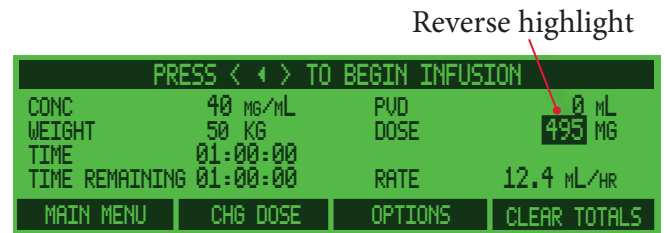

### Overridden limits in reverse

When a soft limit is overridden, as described previously in “Soft Limits”, the overridden values are displayed in reverse highlight.

### Invalid infusion parameter combination

The pump has several types of limits: physical limits, those imposed by the syringe size in use, and drug program limits.

When the PharmGuard® software limits and the pump physical limits cannot be reconciled, the alarm **“INVALID INFUSION PARAMETER COMBINATION”** or **“CALCULATED RATE OUT OF RANGE”** is displayed. At this point, the only possible corrective action is to silence the alarm, look at the prompt to determine which values were to be entered, press **BACK** one or more times, and attempt to re-enter valid values. An example of an invalid infusion parameter combination is one where the pump physical maximum is lower than the software minimum, or vice-versa. Whenever a **“CALCULATED RATE OUT OF RANGE”** or, in certain cases of an **“INVALID INFUSION PARAMETER COMBINATION”** alarm occurs, it is possible that the drug program created in PharmGuard® Toolbox 2 is such that no valid entry is possible, in which case you will need to document the issue and request an update for custom Configuration.

It may be useful to check calculations using a calculator and formula to help identify issues with invalid infusion parameters. If a pump has recurring issues with invalid infusion parameters, contact the person(s) responsible for configuring pumps.

## **PharmGuard® Supported Syringes (PSS) Series 2**

Each manufactured syringe has unique characteristics. These characteristics differ by model and syringe size. The Medfusion® Model 3500 pump V6 uses the specific characteristics to accurately deliver fluid.

Included with PharmGuard® Toolbox 2 are several commonly used Medfusion® Standard Syringes Series 2 for a facility to choose from. These syringes are chosen for use in a Configuration via PharmGuard® Toolbox 2.

PharmGuard® Supported Syringes (PSS) Series 2 allow the addition of a wide range of available syringe models and sizes to PharmGuard® Toolbox 2, for use in creating Drug Programs. PSS Series 2 files must be added via PharmGuard® Toolbox 2 when creating a custom Configuration. Contact Smiths Medical for a complete list of available PharmGuard® Supported Syringes (PSS) Series 2.

(The Medfusion® Standard Syringe Series 2 models and sizes are listed in the Technical Information section of this manual on page 128.) Specific technical information, including syringe flow rate and minimum volume, is also supplied in the literature accompanying PharmGuard® Toolbox 2 and the PharmGuard® Supported Syringes (PSS) Series 2. Refer to [www.smiths-medical.com](http://www.smiths-medical.com) or contact Customer Service for more information about available PharmGuard® Supported Syringes (PSS) Series 2.

---

---

**WARNING:** Only use the Medfusion® Standard Syringes Series 2 (supplied with PharmGuard® Toolbox 2, and included in the Medfusion® Standard Configuration), or the models and sizes available as part of the PharmGuard® Supported Syringes (PSS) Series 2, and always confirm that the syringe model and size displayed on the pump matches the model and size loaded into the pump. Use of unapproved syringes may cause improper pump operation resulting in inaccurate fluid delivery or occlusion sensing or other potential hazards.

---

---



## Navigating the pump menus

There are some general rules for navigating pump menus. Most of the pump programming steps are accomplished by looking to the display screen, and pressing the softkeys indicated. For example:

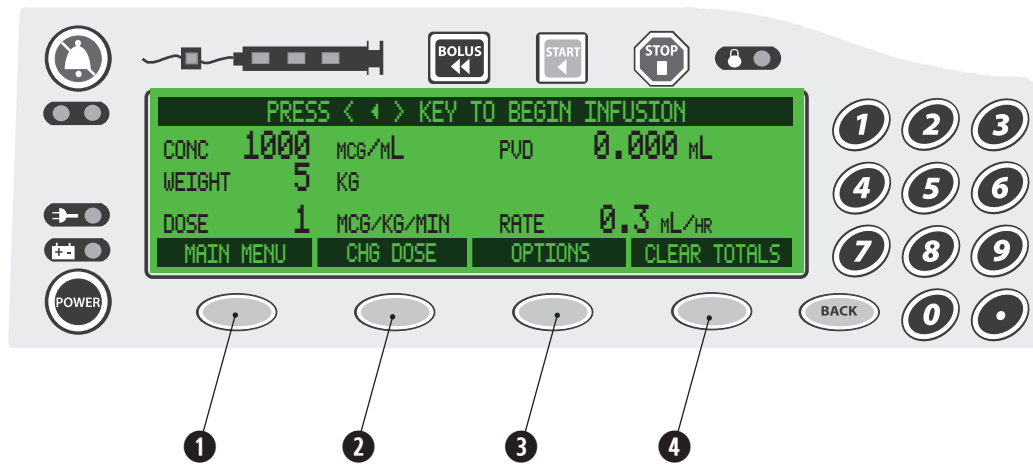

The screen shown above is an example of a “**BEGIN INFUSION**” screen. Pressing softkey “1” opens the **MAIN** menu; pressing softkey “2” initiates the screens for changing the dose value; pressing softkey “3” opens the **OPTIONS** menu; pressing softkey “4” clears the infusion volume and dose totals stored in pump memory.

The softkeys change for different screens, and some screens will have only certain of the softkeys active, or even no active softkeys. Always look to the display to see what the softkeys are used for.

When programming a value or to enter a menu, in most cases the **number** and **decimal** keys on the right side of the keypad are used. (In many cases once a value is entered, you will need to press a softkey to “**Enter**” or save the value or to open the menu.)

Some menus are very large and there will be more items to choose from than can fit on a single display screen. In those cases one of the softkeys will be “**More**”, indicating there are more options available and **More** can be pressed to view them. On those sorts of menus, once the end of the choices is reached, the **More** key becomes **Beginning**, indicating **Beginning** can be pressed to go back to the first “page” of the menu.

If a mistake is made in programming, or a menu opened accidentally, press **BACK** to return to a previous screen or menu.

### Legend

In this manual, menu information that appears onscreen is shown in bold and small capitals (for instance, **SELECT THE PROFILE**). Text associated with softkeys is shown as bold (for instance, **Enter**).

### The Workflow Process

The basic workflow for programming and delivering an infusion is shown in the diagram on the following page.

The infusion may consist of several distinct deliveries, possibly including a loading dose, main infusion, one or more boluses during the main infusion, as well as a flush or KVO infusion once the main infusion is complete. It is possible that all of these parts are programmed in the initial infusion setup sequence, or they may also be added at a later time (after the initial setup but before pressing **START** to start the infusion, or in some cases after the infusion is started).

Because the pump has multiple customizable features, actual Drug Programs and manual infusions may have other delivery options and confirmation screens included that are not shown in the diagram. These additional options and screens are dependent on the custom Configuration created in PharmGuard® Toolbox 2.

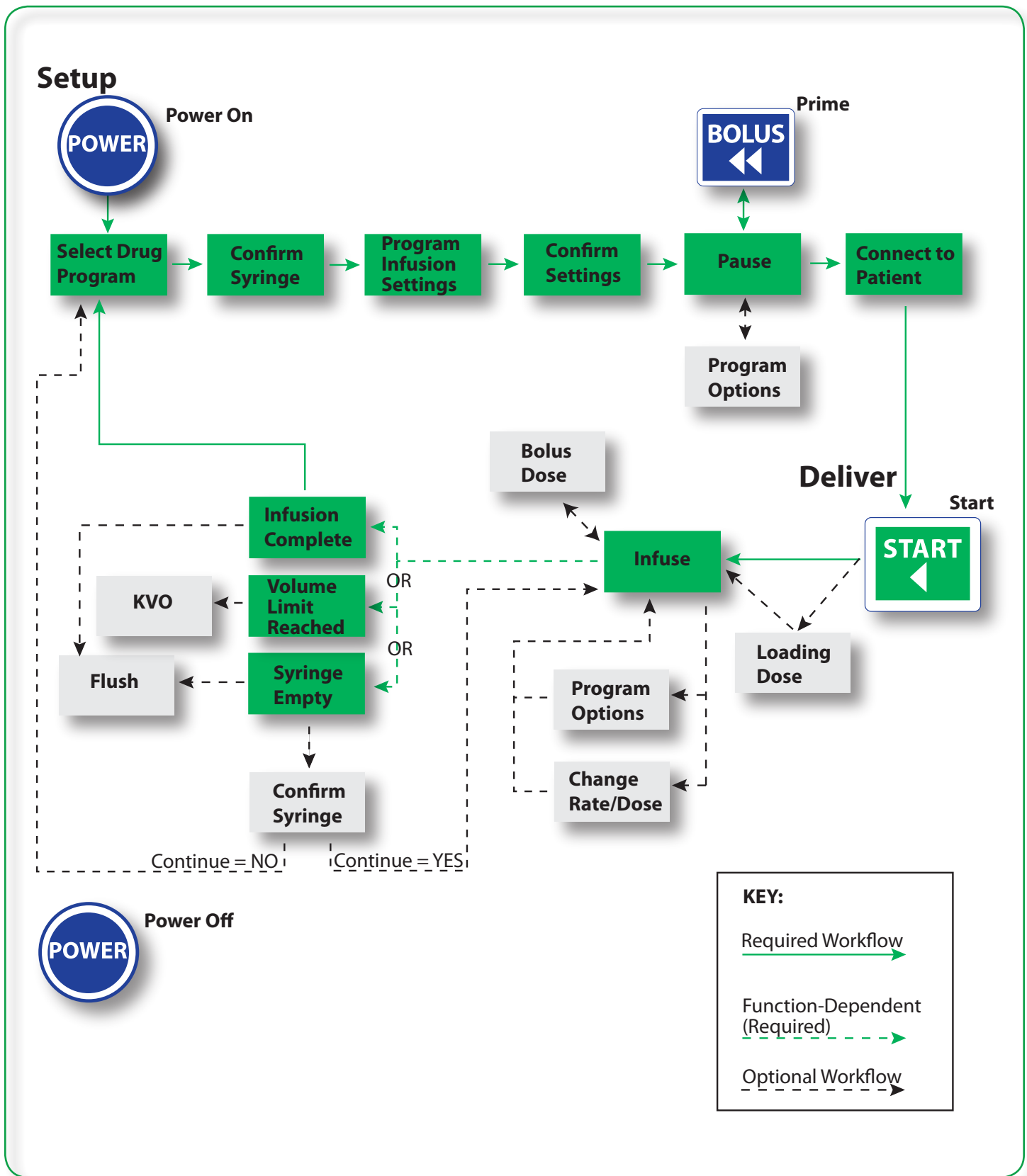

# The Workflow Process

## Guidelines for enhanced pump performance

The following are guidelines for enhanced syringe pump performance. Review occlusion time and flow delivery graphs (starting on page 92). Use appropriate syringe size, tubing, and inline devices for expediting delivery of medication or fluid. Certain factors enhance syringe pump performance, where performance is defined as:

- Time to Detect Occlusion
- Continuity of Flow
- Startup Time

### Always use the smallest syringe for volume of fluid being delivered

**WARNING:** Use the smallest syringe size necessary to deliver the fluid or medication. Using a large syringe at very low rates (below Minimum Recommended Rate for the syringe) may cause improper pump operation, delayed occlusion sensing, larger post occlusion bolus at higher occlusion limit settings, delivery inaccuracies, or other potential hazards. **Bolus Volume:** Delivering a bolus volume less than the recommended bolus volume for the syringe used may result in delivery inaccuracies. Use an infusion set with the smallest diameter tubing available that does not result in excessive back pressure at the desired flow rate. Consider priming, loading, bolus, and flush rates when selecting an infusion set.

If accuracy is of prime concern, use only syringes that meet the  $\pm 2\%$  requirement of the ISO 7886-2 Standard.

Friction and compliance of the syringe plunger tip affect delivery startup and flow continuity. The bigger the syringe, the greater the friction and compliance, the slower the startup. Use a smaller syringe when running at a lower rate.

The tables on page 129 show the recommended minimum delivery rates for the standard syringes (included with PharmGuard® Toolbox 2) by syringe size. Similar information is provided in the documentation supplied with PharmGuard® Supported Syringes (PSS) Series 2. When

programming flow rates, a limit priority alarm will be activated, along with an advisory message on the screen, if a rate that falls outside those recommended is entered.

---

**Note:**

- FlowSentry™ pressure monitoring is not available for all syringe sizes or types. Check the documentation that came with the Medfusion® Standard Syringes Series 2 (supplied with PharmGuard® Toolbox 2) and/or PSS Series 2 for information on the availability of FlowSentry™ pressure monitoring.
  - Fluids with higher viscosity may cause false occlusion alarms at lower settings. When infusing higher viscosity fluids, adjust the occlusion alarm setting to minimize false occlusion alarms.
  - If a rate below that shown on the tables on page 129 or in the documentation supplied with the PharmGuard® Supported Syringes (PSS) Series 2 is entered, the **RATE BELOW RECOMMENDED MIN FOR SYRINGE SIZE** alarm will occur (see page 105 for a full explanation of the alarm). The absolute minimum rate allowed by the pump with a given syringe is listed in the tables found on page 129, and included in the literature supplied with the PharmGuard® Supported Syringes (PSS) Series 2.
-

## Bolus Volume

The recommended minimum bolus volume is 1 mL or 10 percent of the syringe volume of the syringe used, whichever is less. In other words, for a 1 mL syringe (regardless of the actual volume of medication contained), the minimum recommended bolus volume is 0.1 mL. For a 60 mL syringe, the recommended minimum bolus volume (regardless of the actual volume of medication contained), is 1 mL. Bolus volumes delivered that are less than the recommended minimum bolus volumes for the syringe used may result in delivery inaccuracies.

Syringe Size	Minimum Recommended Bolus Volume
1 mL	0.1 mL
3 mL	0.3 mL
5 mL	0.5 mL
6 mL	0.6 mL
10 mL	1 mL
12 mL	1 mL
20 mL	1 mL
30/35 mL	1 mL
50 mL	1 mL
60 mL	1 mL

## Use appropriate internal diameter tubing

For the most consistently precise control of all fluids and medications, it is recommended to use appropriate *internal diameter tubing*, as well as to *minimize residual volumes* between syringe and patient by reducing:

- a) Tubing internal diameter (generally, for rates under 5 mL/hr small internal diameter tubing is recommended; for rates 5 mL/hr or above, tubing with a larger internal diameter should be used to reduce occlusion alarms)
- b) Tubing length
- c) Size of in-line filters
- d) Number of stopcocks

This makes the infusion setup less variable or compliant, which in turn reduces the start time for fluid to reach the patient – and reduces time required for detecting an occlusion and maintains delivery accuracy.

Use only the standard syringes specified on the table on page 128 and supplied with PharmGuard® Toolbox 2, or supplied with the PharmGuard® Supported Syringes (PSS) Series 2 (available from Smiths Medical). Smiths Medical also provides a variety of infusion sets that can be used with the pump. See [www.smiths-medical.com](http://www.smiths-medical.com) for information regarding infusion sets available from Smiths Medical, or contact your sales representative.

# Programming an Infusion

## Turn the pump on

Below right is an illustration of a startup screen, and a list of basic steps for turning the infusion pump on.

1. Press and hold  until the display turns dark. Verify the display shows all pixels on, then all pixels off.
2. The pump “beeps” twice, one low beep and one high beep. This is a test of the standard audible alarm and the battery backup audible alarm (high tone). The Alarm, Infusing and Lock indicators flash as the self-test cycles and the startup screen appears. The Device ID, if it has one, appears in the middle left corner. (In this example, it is called “HOSPITAL”.) The pump serial number will appear at the middle right (in this example, it is “M001234”).
3. Verify the display indicates successful completion of system startup self-tests.

**If the pump does not turn on with successful completion of self-tests**, remove it from service and have it checked by a trained biomedical technician.

**IMPORTANT:** Do not move the Syringe Plunger Driver or otherwise manipulate the pump until the startup tests are complete and the Profile selection screen appears. Sensors are tested as part of the startup process, and manipulating the pump during this process may cause it to detect false sensor failures, resulting in alarms.

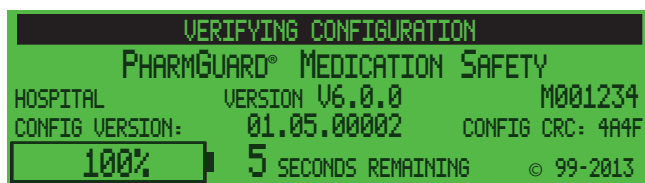
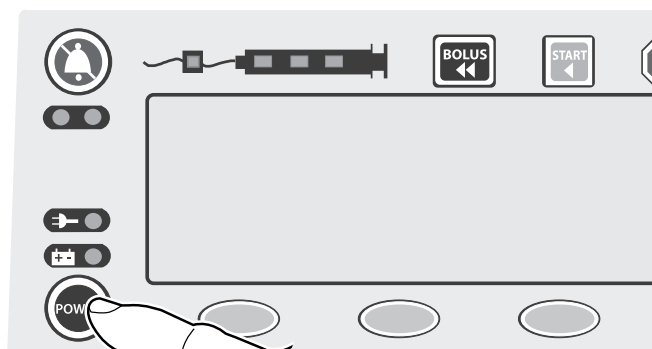

## Turning the pump off



The pump can be turned off at **any time**, in any delivery mode, while the pump is running.

**Note:** If there are any alarms sounding, you must first silence the alarm by pressing  before the pump can be turned off.

### With the pump infusing:

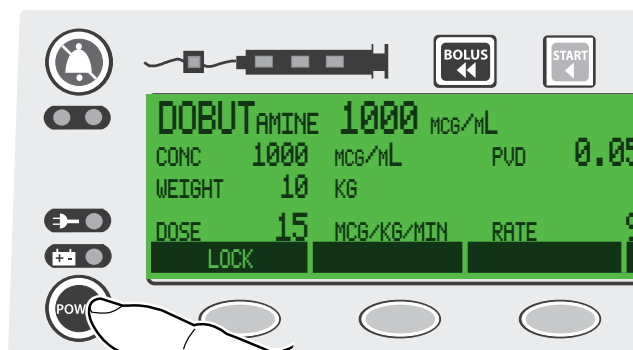
1. Press and hold .



The **PRESS POWER AGAIN TO SHUTDOWN** screen appears. *Infusion has not stopped at this point.* (If  is not pressed again, a low priority alarm sounds every two minutes until  is pressed again, or **Cancel** or  is pressed.)

2. Press and hold  again to turn the pump off. To cancel press **Continue** or .

Infusion stops when the pump is turned off.

### With the pump stopped:

1. Press and hold . The pump turns off.

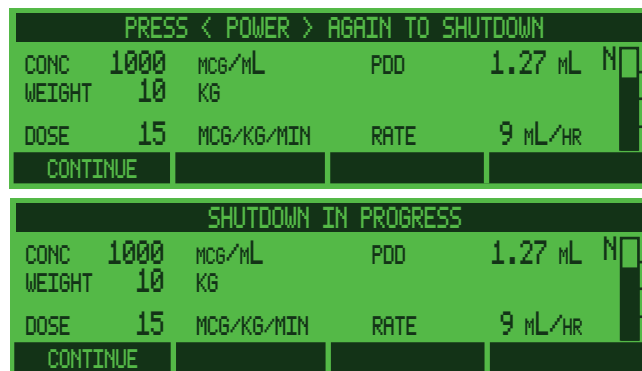



## Selecting a Delivery Mode and Programming an infusion

Due to the customization capabilities of the Medfusion® Model 3500 pump V6, the screen shown once power-up is complete depends entirely on what, if any, customization was performed.

Typically a Custom Configuration will have been created using PharmGuard® Toolbox 2, and have been sent to the pump. If a Configuration with Profiles was sent to the pump, the pump will stop at the “**SELECT THE PROFILE**” **MAIN** menu.

If no Custom Configuration was sent to the pump, the pump will stop at the “Medfusion® Standard Configuration” **MAIN** menu.

If the Custom Configuration sent to the pump consists of only one profile containing a Quick library, the pump stops at the Quick library menu. If only one profile is programmed and Quick library not used, the pump goes right to the Category/Delivery Modes screen.

The graphic on the following page shows the general steps required to program and start an infusion. Specific instructions for programming the various settings, delivery modes and options follows.

## General Infusion Programming Procedure

Load desired syringe (may also be done when it comes up in the programming process)

### Custom Configuration:

Select a Profile

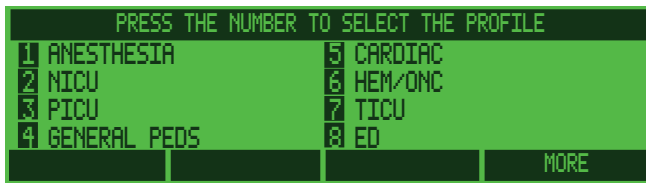

Select a Category or manual delivery mode

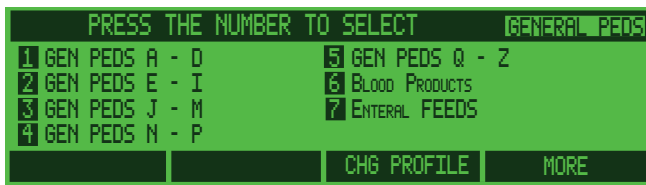

Select a Drug Program

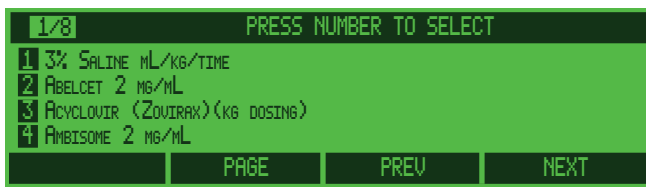

### Medfusion® Standard Configuration:

Select a manual delivery mode



Select a Syringe Model/Size

[If not done previously, load desired syringe]  
Verify model and size

Program required infusion parameters as they appear in programming process

If desired (and if available), program desired Options

Prime infusion set and pump

Start infusion

## Selecting an Infusion

Following are the steps for selecting an infusion type for programming an infusion.

The Profiles, Categories or Delivery Modes, and drug programs available on a pump are dependent on how the pump was configured, and whether a custom Configuration was created using PharmGuard® Toolbox 2 (performed by whomever is responsible for customizing the pump before it was delivered to a work area). The actual screens on the pump may look very different from those shown here.

After successfully completing its system startup self-tests, the pump displays one of the following menus (depending on the pump's configuration).

## Select a Profile (Custom Configuration)

After successfully completing its system startup self-tests, a pump with a Custom Configuration with multiple profiles defined will display **SELECT THE PROFILE**.

Pumps can be configured so that all or some of the profiles require a passcode to access them. If that is the case, the appropriate passcode must be entered to access the profile.

**Note:** If only a single Profile was set up for use on the pump (using PharmGuard® Toolbox 2), none of these screens will appear. The pump will instead display the drug category selection screen following successful system startup self-tests.

- The configuration profiles, categories and drug programs available on the following screens are dependent on which were set up in the custom Configuration. The actual screen on the pump may look very different from the ones shown here.
1. Press any **number** key to select the desired profile. If a mistake is made, press **BACK** to return to the **SELECT THE PROFILE** screen.
  2. If the desired profile is not displayed, press **More** to display the next page of profiles. Either:
    - a) Select a profile by pressing its **number** and continue the programming process. **OR**
    - b) Press **Beginning** to return to the first page of the **SELECT THE PROFILE** screen.
  3. If required, enter the profile passcode, then press **Enter**.

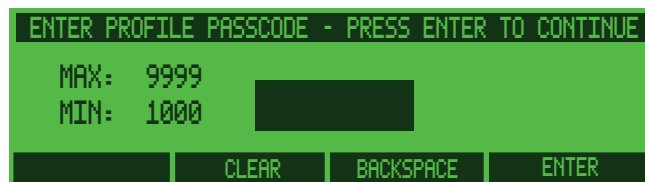
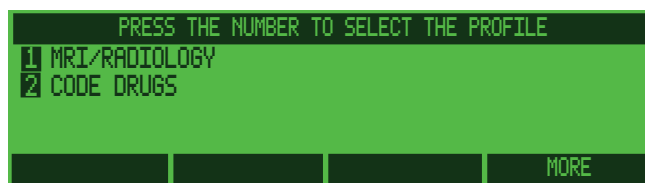
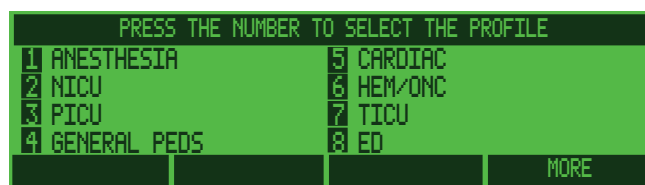

### Select a Category

4. Once inside a profile, select a category by pressing its **number**. If a category cannot be found, press **CHG Profile** to return to the **SELECT THE PROFILE** menu. Each Profile can have a maximum of 8 Categories with up to 36 Drug Programs each, resulting in a maximum of 288 entries per Profile. The actual number of drug programs is dependent on the content of each drug program and on the amount of available pump memory.

#### “Quick” Library

- a. If the Profile selected includes a “Quick” Library, the Quick Library’s drug program selection screen displays.
- b. Select a drug program by pressing its **number**. (If Quick Library drug programs are not desired, press **Main Menu** to exit the Quick library and display the category choices for further drug program selections.) Item 4, above, applies to Quick Library as well.
- c. The far left softkey can be pressed to access the Quick Library. The key will reflect the actual name assigned to the Quick Library in the Configuration (**Quick Library** is only an example).

### Select a Drug Program

5. Select a Drug Program by pressing its **number**. Note the number of pages in the category is displayed, along with the current page (in this example, 2/8). If the desired drug program is not displayed (and provided the category contains more drug programs), press **Next** (or, if you know the page number of the drug program you want, press **Page** then use the **number** key for the page). Once past page 1 of the category, press **Prev** to move back a page.

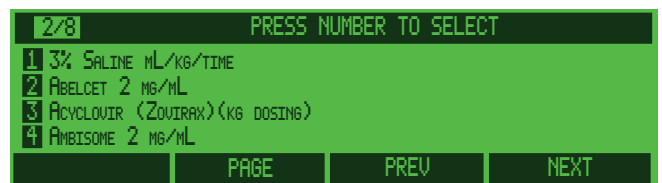
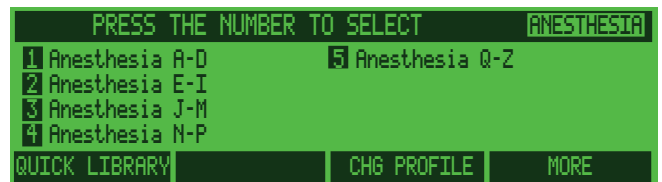
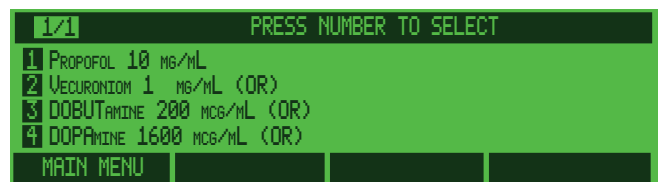
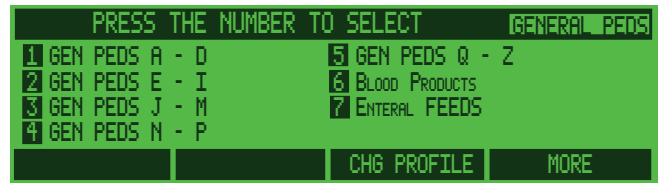

The pump requires a confirmation for drug program selections; press **Yes** to confirm the selection, or press **No** to return to the **SELECT** screen.

If “manual” modes are available in the custom Configuration and selected for an infusion, the pump prompts for a confirmation as well. Press **Yes** to confirm the selection, or press **No** to return to the **Select** screen.

After a drug program selection is made the pump will prompt to select the syringe model and size before programming the selected mode (see page 32).

Specific information for programming the various delivery types follows the instructions for the syringe.

### Select a Delivery Mode (Medfusion® Standard Configuration)

- 1 If the pump does not have a custom Configuration, the Medfusion® Standard Configuration menu displays.
2. Select a delivery mode by pressing its **number**. If the desired mode is not displayed, press **More** to display additional delivery modes (if present).
3. The pump requires confirmation of manual mode selection. Press **Yes** to confirm the selection, or press **No** to return to the **SELECT** screen.

After a delivery mode selection is made the pump will prompt to select the syringe model and size before programming the selected mode (see page 32).

Specific information for programming the various delivery types follows the instructions for the syringe.

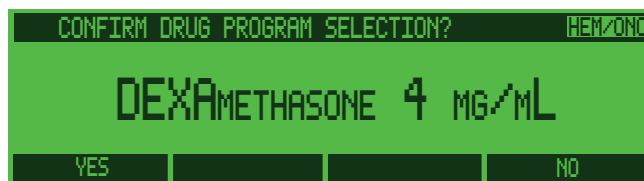



## Loading a syringe and syringe model setup

Once a Drug Program or manual delivery mode has been chosen, specify the syringe model and size, and load the syringe. Pumps can be customized to allow for use of a wide variety of syringe brands and sizes, or can limit to as few as a single syringe brand. **If a pump has been customized to a single syringe brand, none of the following screens will appear.**

Syringe setup and loading is a multi-step process, based on your daily practice of infusing patients with medications or other fluids.

Use your facility's standard protocol for preparing an infusion.

---

**WARNING:** Only use the Medfusion® Standard Syringes Series 2 (supplied with PharmGuard® Toolbox 2, and included in the Medfusion® Standard Configuration), or the models and sizes available as part of the PharmGuard® Supported Syringes (PSS) Series 2, and always confirm that the syringe model and size displayed on the pump matches the model and size loaded onto the pump. Use of unapproved syringes may cause improper pump operation resulting in inaccurate fluid delivery or occlusion sensing or other potential hazards.

---



---

**Note:** Pharmacy labels placed on the syringe may interfere with the pump's syringe sensors. To avoid interference, place pharmacy labels at least 1 inch from the flange (so that the Syringe Barrel Clamp does not rest on a label), and orient the syringe so the label faces upward and does not rest on the pump.

---

**IMPORTANT:** Do not move the Syringe Plunger Driver or otherwise manipulate the pump until the startup tests are complete and the Profile selection screen appears. Sensors are tested as part of the startup process, and manipulating the pump during this process may cause it to detect false sensor failures, resulting in alarms.

---

1. Inspect the syringe to identify the model and size.
2. Press a **number** key to select the syringe model being used.

**Note:** If, when the pump was powered up, the syringe barrel clamp was pulled up and resting on the pump handle, a **CHECK SYRINGE BARREL CLAMP** alarm may occur immediately upon selecting a syringe model (manufacturer). Press  to silence the alarm, press **Confirm**, then continue with these instructions for loading a syringe.

3. It is now time to load the syringe. (The arrows shown on screen indicate that the syringe sensors detect that the syringe is not loaded.)

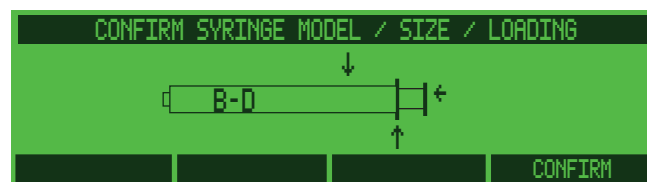

4. Lift upward on the Syringe Barrel Clamp and turn it so it is out of the way.

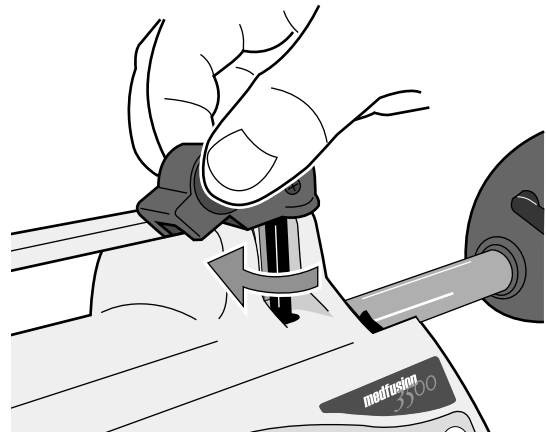
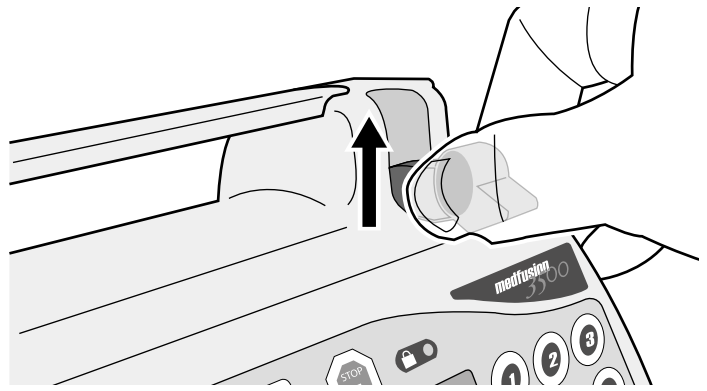

5. Squeeze the Plunger Release Lever on the syringe plunger driver and pull gently to extend it all the way outward.

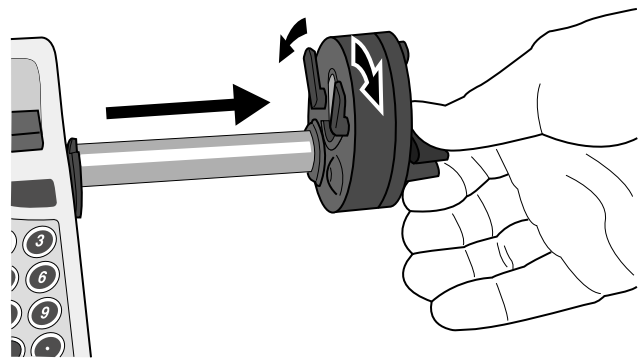

---

**WARNING:** Verify that the plunger holders securely capture the syringe plunger. Make sure to capture the syringe barrel and flange. Failure to properly secure the syringe could result in uncontrolled fluid flow to the patient, which could result in serious injury or death.

---

6. Load the syringe onto the pump as illustrated, making sure the flange of the syringe barrel is pressed or rolled into the Flange Clip.

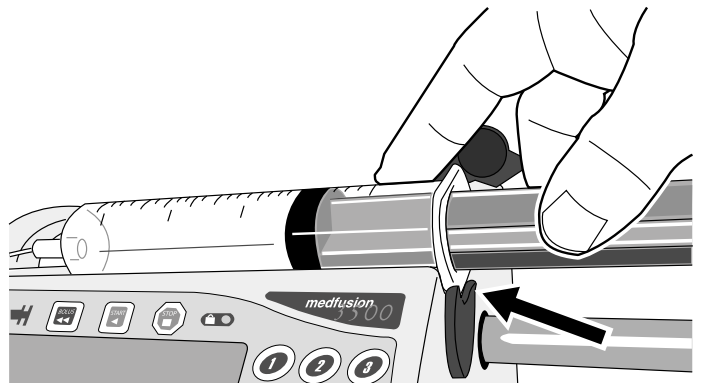

- Squeeze the Plunger Release Lever on the syringe plunger driver and push it toward the syringe plunger; once it is flush with the syringe plunger release the lever. Be sure both holders close around the syringe plunger.

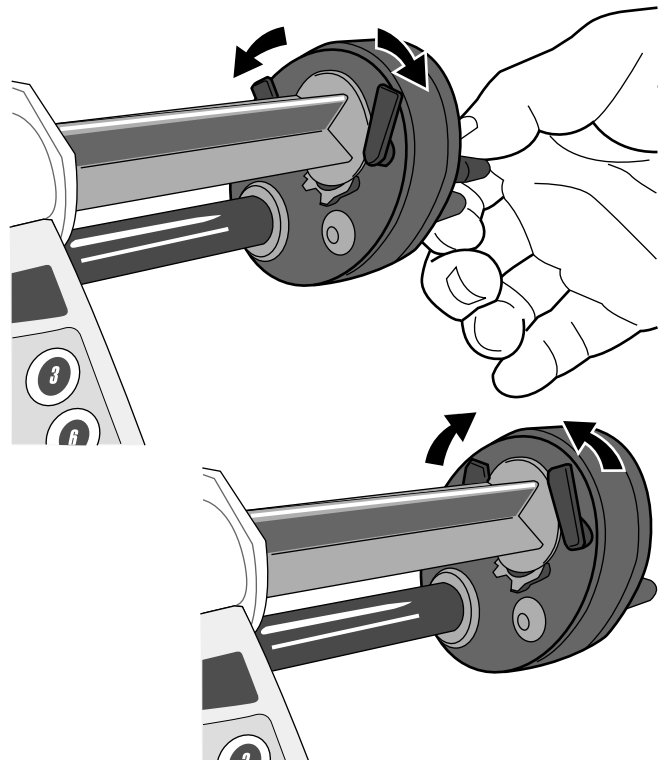

- Turn and lower the Barrel Clamp onto the barrel of the syringe.

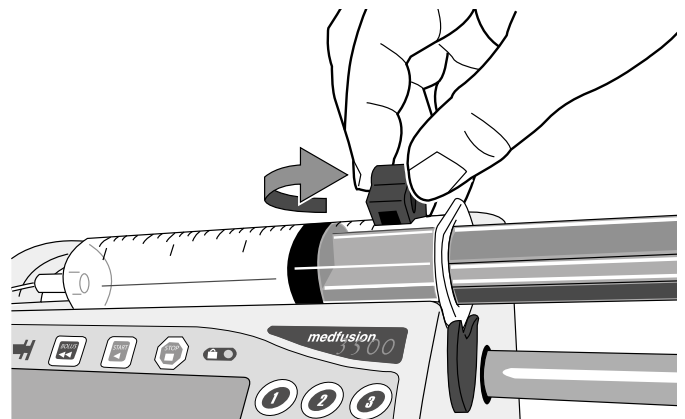

**WARNINGS:**

- Verify that the plunger holders securely capture the syringe plunger. Make sure to capture the syringe barrel and flange. Failure to properly secure the syringe could result in uncontrolled fluid flow to the patient, which could result in serious injury or death.
- Always use the **Prime** function on the pump when loading a new syringe in order to remove any mechanical slack. Failure to prime correctly can delay infusion delivery and cause Total Volume Delivered to read higher than the amount actually delivered to the patient.

The size should now appear in the display.

**Note:** If the syringe is incorrectly loaded, guide arrows appear on screen to identify the problem.

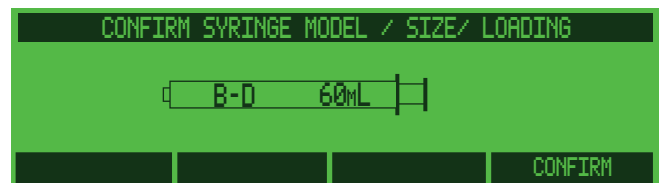
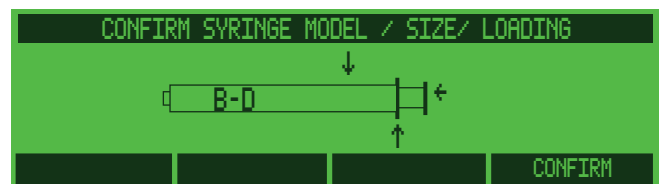

**Arrow pointing down "↓"** means check syringe barrel clamp.  
**Arrow pointing left "←"** means check syringe plunger holders.  
**Arrow pointing up "↑"** means check syringe flange clip.

**Note:** Some syringes may have similar outer dimensions, despite being different sizes (for example, BD® 1mL Luer Lok™ and 3mL syringes), or even different models. In these cases, the pump will display size options, requiring selection of the correct syringe size actually in use. Always verify that the syringe model shown is what is actually in use (if not, press **BACK** and select the correct model).

9. Make sure the pump correctly recognizes the syringe size, and the syringe model is correct. If not, verify that the model and size are available on the pump (contact the person within the facility responsible for customizing the pump for more information, if necessary).

**WARNING:** Only use the Medfusion® Standard Syringes Series 2 (supplied with PharmGuard® Toolbox 2, and included in the Medfusion® Standard Configuration), or the models and sizes available as part of the PharmGuard® Supported Syringes (PSS) Series 2, and always confirm that the syringe model and size displayed on the pump matches the model and size loaded onto the pump. Use of unapproved syringes may cause improper pump operation resulting in inaccurate fluid delivery or occlusion sensing or other potential hazards.

10. Thread the tubing through the three Tubing Holders on the top left side of the pump.

**WARNING:** Periodically check the fluid pathway and all connections (including the catheter/administration set connection) for leaks. Leaks in the system may cause fluid loss resulting in under-delivery, as well as allowing an opening for contamination.

11. Press **Confirm** to confirm the syringe information.

The pump will now automatically display the programming screens for the delivery mode chosen. Since there are many modes to choose from, in which a wide variety of functions within that mode may or may not have been enabled, what follows is an explanation of the programming steps required

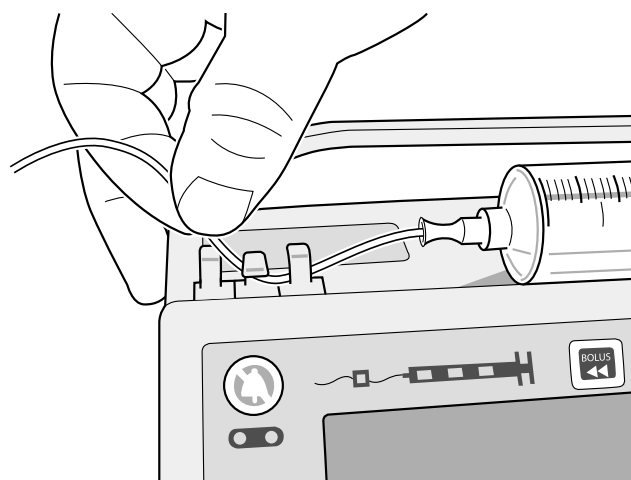
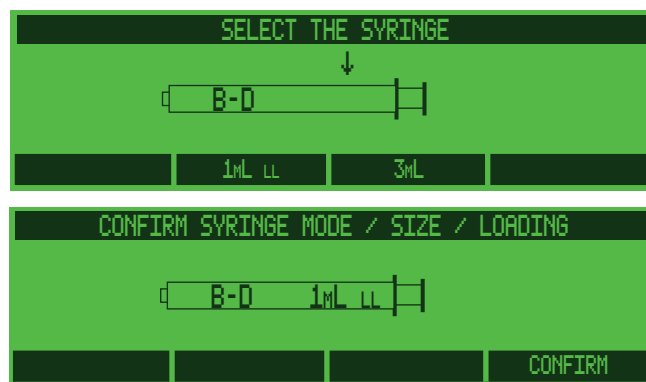

for each possible delivery mode with all functions enabled.

### Unloading the syringe

---

---

**WARNING: Turn off fluid flow.** Always turn off fluid flow to patient in tubing via clamp or stopcock before loading or unloading a syringe. Uncontrolled fluid flow can occur when infusion set is not clamped or turned off resulting in inappropriate delivery rate, and may cause serious injury and/or death.

---

---

Unload a syringe exactly the opposite way as it was loaded. Just use the following steps:

1. Press  to stop delivery.
2. Clamp or close infusion line from the syringe to the patient.
3. Unthread the tubing from the Tubing Holders on the top left side of the pump.
4. Lift and swivel the syringe Barrel Clamp out of the way.
5. Squeeze the Plunger Release Lever on the syringe plunger and remove the syringe.

## Programming Infusions

### Continuous mode: mL/hr

Continuous infusion is programmed by setting a *flow rate in mL/hr*. Actual range limits for flow rate are determined by syringe model and size (see the table in Technical section (page 129) of this manual and/or the product literature supplied with PharmGuard® Toolbox 2 or the PharmGuard® Supported Syringes [PSS] Series 2) or by a custom configured maximum rate. If needed, and if the options have been enabled using PharmGuard® Toolbox 2, a volume limit, loading dose, or bolus dose can also be programmed.

To program a Continuous mode infusion, at the selection menu, choose **ML/HR** (or choose a drug program that uses the continuous mode infusion type). Choose the syringe model and size, and load the syringe as instructed on page 32.

1. Use the **number** keys and (if needed) the decimal point to set the flow rate. Press **Clear** to clear an entry. Press **Backspace** to erase a character. Press **Enter** to accept the setting.
2. After all infusion values are set, the pump pauses at the **BEGIN INFUSION** screen (the pump may be configured with additional confirmation screens, requiring confirmation of all settings twice before beginning the infusion).
3. If desired, program a Bolus Dose, Loading Dose or Volume Limit (see Options, page 59).
4. Prior to connecting to the patient, press  to initiate the priming sequence (page 57).
5. Confirm the settings and start the infusion, or use the four menu softkeys to modify the settings.

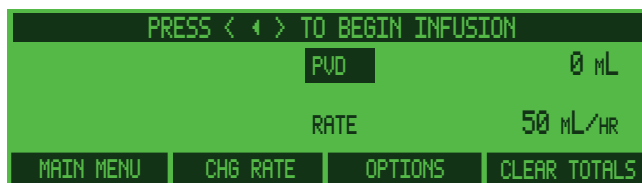

**Main Menu** – returns to the **MAIN MENU**.

**Chg Rate** – allows modifying the set rate.

**Options** – selection from a list of variables (e.g., bolus, volume limit, etc.).

**Clear Totals** – clears total volume delivered, and PVD or PDD.

---

**WARNING: Confirm All Settings.** Before starting *any* delivery, *always* confirm the accuracy of *all* infusion values to the original order. Programming the pump at a delivery rate other than that prescribed will cause inappropriate delivery, which can result in serious injury or death.

---

6. When all delivery settings are confirmed as correct, press  to begin the infusion.



## Dose / Min and Dose / Hr

The Dose / Min and/or Dose / Hr modes may be available on a pump.

Program them by setting:

- **Drug concentration units** (i.e., g/mL, mg/mL, mcg/mL, mMol/mL, mEq/mL, or Units/mL)
- **Drug concentration**
- **Drug delivery units** (i.e., g, mg, mcg, ng, mMol, mEq, or Units)
- **Dose rate**

- **Volume limit, KVO, loading dose, or bolus dose may also be programmed (these options are only available if they have been enabled in the profile or specified in the Drug Program using PharmGuard® Toolbox 2)**

At the selection menu, choose either **DOSE/MIN** or **DOSE/HR** (or choose a drug program that uses the infusion type). Choose the syringe model and size, and load the syringe as instructed on page 32.

1. Use the **number** keys to select the medication concentration **units**. (The actual units available on a pump depends on the custom setup.) Press **Enter** to accept the medication concentration units.
2. Use the **number** keys to set medication concentration. Concentration is limited to 4 digits. Press **Clear** to clear an entry. Press **Backspace** to erase a character. Press **Enter** to accept the setting.
3. Use the **number** keys to set the delivery units. (The actual units available on a pump depends on the custom setup.) *If only one delivery unit is available for the concentration units selected, this screen will not appear.* Press **Enter** to accept the delivery units.
4. Use the **number** keys to set dose rate. Range limits for dose rate are determined by syringe size and/or the custom setup in the Configuration. The high and low rate limits display on screen. When the dose is correct, press **Enter**.
5. At the **BEGIN INFUSION** screen all values are set and the pump pauses (the pump may be configured with additional confirmation screens, requiring confirmation of all settings again before beginning the infusion).

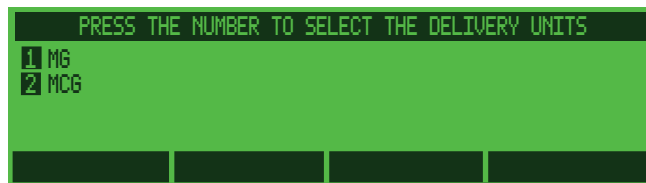
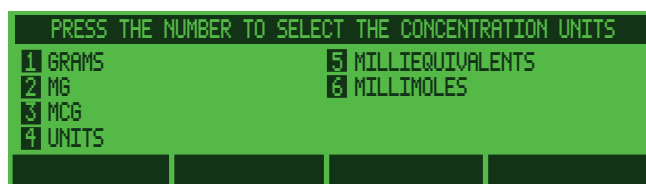

6. Confirm the settings and start the infusion, or use the four menu softkeys shown at right to modify the settings.
7. Prior to connecting to the patient, press  to initiate the priming sequence (page 57).
8. If desired, program a Bolus Dose, Loading Dose or Volume Limit (see Options, page 59).

---

**WARNING: Confirm All Settings.** Before starting *any* delivery, *always* confirm the accuracy of *all* infusion values to the original order. Programming the pump at a delivery rate other than that prescribed will cause inappropriate delivery, which can result in serious injury or death.

---

9. When all delivery settings are confirmed as correct, press  to begin infusion.

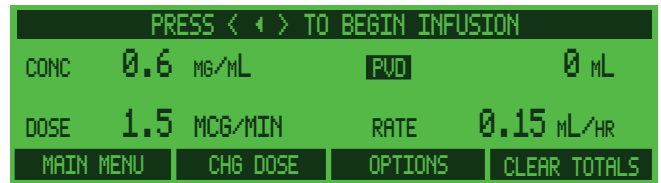

**Main Menu** – returns to the **MAIN MENU**.

**Chg Dose** – allows modifying the set dosage without starting from scratch.

**Options** – allows selection from a list of variables (e.g., bolus, volume limit, etc.).

**Clear Totals** – clears total volume delivered, and PVD or PDD.

## Dose / Day

The Dose / Day mode may be available on a pump.

Program Dose / Day by setting:

- **Drug concentration units** (i.e., g/mL, mg/mL, mcg/mL, mMol/mL, mEq/mL, or Units/mL)
- **Drug concentration**
- **Drug delivery units** (i.e., g, mg, mcg, ng, mMol, mEq, or Units)
- **Dose rate**

- **Volume limit, KVO, loading dose, or bolus dose may also be programmed (these options are only available if they have been enabled in the profile or specified in the Drug Program using PharmGuard® Toolbox 2)**

At the selection menu, choose **DOSE/DAY** (or choose a drug program that uses the infusion type). Choose the syringe model and size, and load the syringe as instructed on page 32.

1. Use the **number** keys to select the medication concentration **units**. (The actual units available on a pump depends on the custom setup.) Press **Enter** to accept the medication concentration units.
2. Use the **number** keys to set medication concentration. Concentration is limited to 4 digits. Press **Clear** to clear an entry. Press **Backspace** to erase a character. Press **Enter** to accept the setting.
3. Use the **number** keys to set the delivery units. (The actual units available on a pump depends on the custom setup.) *If only one delivery unit is available for the concentration units selected, this screen will not appear.* Press **Enter** to accept the delivery units.
4. Use the **number** keys to set dose rate. Range limits for dose rate are determined by syringe size and/or the custom setup in the Configuration. The high and low rate limits display on screen. When the dose is correct, press **Enter**.
5. At the **BEGIN INFUSION** screen all values are set and the pump pauses (the pump may be configured with additional confirmation screens, requiring confirmation of all settings again before beginning the infusion).
6. Confirm the settings and start the infusion, or use the four menu softkeys shown at right to modify the settings.

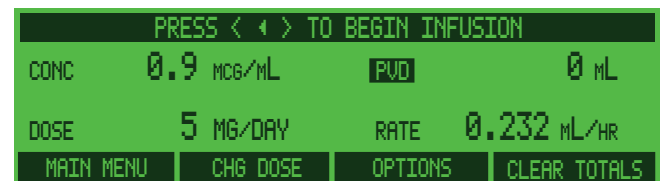
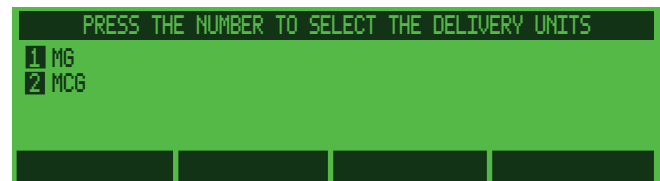
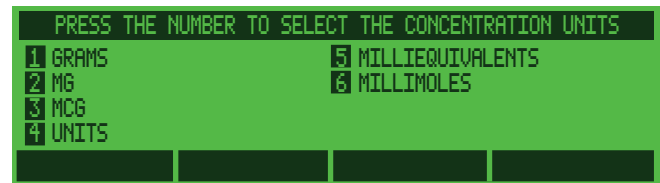

**Main Menu** – returns to the **MAIN MENU**.

**Chg Dose** – allows modifying the set dosage without starting from scratch.

**Options** – allows selection from a list of variables (e.g., bolus, volume limit, etc.).

**Clear Totals** – clears total volume delivered, and PVD or PDD.

7. Prior to connecting to the patient, press  to initiate the priming sequence (page 57).
8. If desired, program a Bolus Dose, Loading Dose or Volume Limit (see Options, page 59).

---

---

**WARNING: Confirm All Settings.** Before starting *any* delivery, *always* confirm the accuracy of *all* infusion values to the original order. Programming the pump at a delivery rate other than that prescribed will cause inappropriate delivery, which can result in serious injury or death.

---

---

9. When all delivery settings are confirmed as correct, press  to begin infusion.

## Dose / Time

The Dose / Time mode may be available on a pump.

Program Dose / Time by setting:

- **Drug concentration units** (i.e., g/mL, mg/mL, mcg/mL, mMol/mL, mEq/mL, or Units/mL)
- **Drug concentration**
- **Drug delivery units** (i.e., g, mg, mcg, ng, mMol, mEq, or Units)

- **Dose rate**
- **Delivery Time**

At the selection menu, choose **DOSE/TIME** (or choose a drug program that uses the infusion type). Choose the syringe model and size, and load the syringe as instructed on page 32.

1. Use the **number** keys to select the medication concentration **units**. (The actual units available on a pump depends on the custom setup.) Press **Enter** to accept the medication concentration units.
2. Use the **number** keys to set medication concentration. Concentration is limited to 4 digits. Press **Clear** to clear an entry. Press **Backspace** to erase a character. Press **Enter** to accept the setting.
3. Use the **number** keys to set the delivery units. (The actual units available on a pump depends on the custom setup.) *If only one delivery unit is available for the concentration units selected, this screen will not appear.* Press **Enter** to accept the delivery units.
4. Use the **number** keys to set dose. Range limits for dose are determined by syringe size and/or the custom setup in the Configuration. The high and low dose limits display on screen. When the dose is correct, press **Enter**.
5. The time setting screen appears. Press the **number** keys to set the time in hours and minutes, then press **Enter**.
6. At the **BEGIN INFUSION** screen all values are set and the pump pauses (the pump may be configured with additional confirmation screens, requiring confirmation of all settings again before beginning the infusion).

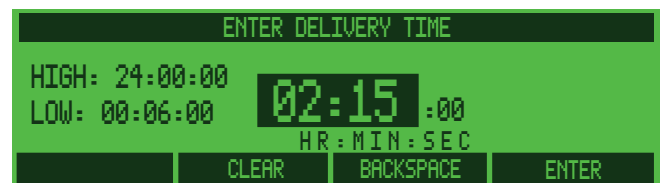
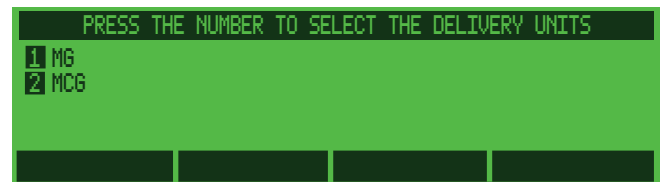
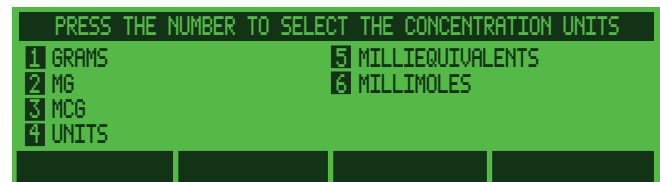

7. Confirm the settings and start the infusion, or use the three menu softkeys shown at right to modify the settings.
8. Prior to connecting to the patient, press  to initiate the priming sequence (page 57).

---

**WARNING: Confirm All Settings.** Before starting *any* delivery, *always* confirm the accuracy of *all* infusion values to the original order. Programming the pump at a delivery rate other than that prescribed will cause inappropriate delivery, which can result in serious injury or death.

---

9. When all delivery settings are confirmed as correct, press  to begin infusion.

PRESS <   > TO BEGIN INFUSION			
CONC	0.6 MG/ML	PVD	0 ML
		DOSE	5 MG
TIME	02:15:00		
TIME REMAINING	02:15:00	RATE	3.7 ML/HR
MAIN MENU		OPTIONS	CLEAR TOTALS

**Main Menu** – returns to the **MAIN MENU**.

**Options** – allows selection from a list of variables (e.g., Standby, etc.).

**Clear Totals** – clears total volume delivered, and PVD or PDD.



## Body weight/surface area infusion deliveries

The following Body weight/surface area -based infusion delivery modes may be available on a pump: dose/kg/min (dose/m<sup>2</sup>/min) – dose/kg/hr (dose/m<sup>2</sup>/hr) – dose/kg/day (dose/m<sup>2</sup>/day).

The body weight/surface area rate calculation allows programming by:

- **Drug concentration units** (i.e., g/mL, mg/mL, mcg/mL, mMol/mL, mEq/mL, or Units/mL)
- **Drug concentration**
- **Drug delivery units** (i.e., g, mg, mcg, ng, mMol, mEq, or Units)
- **Patient's weight/Body surface area**
- **Dose**

- **Volume limit, KVO, loading dose, or bolus dose may also be programmed (these options are only available if they have been enabled in the custom program using PharmGuard® Toolbox 2)**

The pump calculates the correct flow rate in mL/hr to achieve the required drug dose. To program a body weight/surface area infusion, at the selection menu, choose either **DOSE/KG/MIN (DOSE/M<sup>2</sup>/MIN)**, **DOSE/KG/HR (DOSE/M<sup>2</sup>/HR)** or **DOSE/KG/DAY (DOSE/M<sup>2</sup>/DAY)** (or choose a drug program that uses the body weight/surface area mode infusion type). Choose the syringe model and size, and load the syringe as instructed on page 32.

1. Press the **number** keys to set the medication concentration **units**. (The actual units available on a pump depends on the custom setup.) Press **Enter** to accept the medication concentration units.
2. Press the **number** keys to set medication concentration. Concentration is limited to 4 digits. Press **Clear** to clear an entry. Press **Backspace** to erase a character. Press **Enter** to accept the setting.
3. Use the **number** keys to set the delivery units. (The actual units available on a pump depends on the custom setup.) **If only one delivery unit is available for the concentration units selected, this screen will not appear.** Press **Enter** to accept the delivery units.
4. Press the **number** keys to set the patient's weight in kilograms or surface area in square meters. Weight/surface area are limited to the indicated range (which may have been customized). Press **Enter** to accept the patient weight/surface area setting.

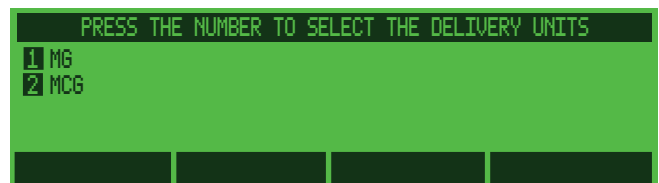
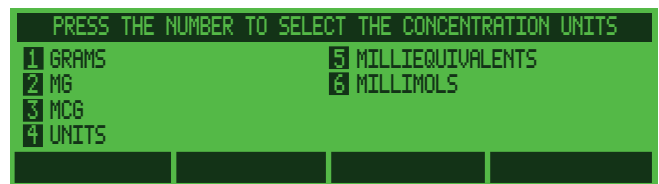

The pump may be customized with an additional patient weight/body surface area confirmation screen. If so, re-enter the patient weight/body surface area, then press **Enter** to accept the setting.

5. At the **DOSE RATE** screen, press the **number** keys to set the dose. Range limits are determined by installed syringe size and/or the custom setup in the Configuration. When the setting is correct press **Enter** to accept the dose.
6. If desired (and if they are enabled), program a Bolus Dose, Loading Dose or Volume Limit (see Options, page 59).
7. At the **BEGIN INFUSION** screen all values are set and the pump pauses (the pump may be configured with additional confirmation screens, requiring confirmation of all settings again before beginning the infusion).
8. Prior to connecting to the patient, press  to initiate the priming sequence (page 57).
9. Confirm the settings and start the infusion, or use the four menu softkeys shown at right to modify the settings.

---

**WARNING: Confirm All Settings.** Before starting *any* delivery, *always* confirm the accuracy of *all* infusion values to the original order. Programming the pump at a delivery rate other than that prescribed will cause inappropriate delivery, which can result in serious injury or death.

---

10. When all delivery settings are confirmed as correct, press  to begin infusion.

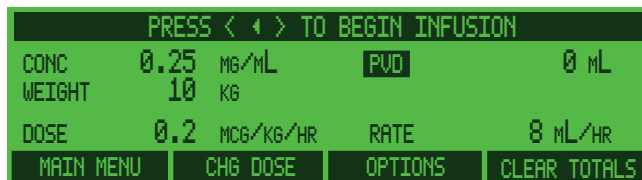
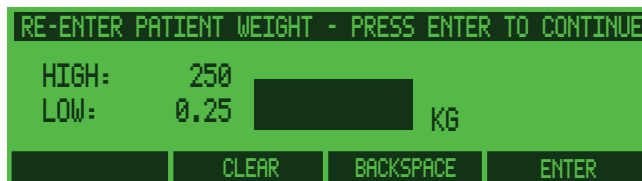

**Main Menu** – returns to the **MAIN MENU**.

**Chg Dose** – allows modifying the set dosage without starting from scratch.

**Options** – allows selection from a list of variables (e.g., bolus, volume limit, etc.).

**Clear Totals** – clears total volume delivered, and PVD or PDD.

## Volume / weight infusions

The following volume/weight modes may be available on a pump: mL/kg/min and mL/kg/hr.

Volume/weight infusion rate calculations allow programming by:

- **Patient's weight**
- **Volume of drug per kilogram of weight**
- **Volume limit, KVO, loading dose, or bolus dose may also be programmed (these options are only available if they have been enabled in the custom program using PharmGuard® Toolbox 2)**

The pump calculates the correct flow rate in mL/hr to achieve the required drug dose. To program a volume/weight infusion, at the selection menu, choose either **mL/KG/MIN** or **mL/KG/HR** (or choose a drug program that uses the volume/weight mode infusion type). Choose the syringe model and size, and load the syringe as instructed on page 32.

1. Use the **number** keys to set the patient's weight in kilograms. Weight is limited to the indicated range. Press **Enter** to accept the patient weight setting.

The pump may be customized with an additional patient weight/body surface area confirmation screen. Re-enter the patient weight, then press **Enter** to accept the setting.

2. At the **VOLUME/KILOGRAM** screen, press the **number** keys to set the volume per weight setting. Range limits are determined by the installed syringe size, patient weight, and/or the custom setup in the Configuration. When the setting is correct press **Enter** to accept it.
3. If desired (and if they are enabled), program a Bolus Dose, Loading Dose or Volume Limit (see Options, page 59).
4. At the **BEGIN INFUSION** screen all values are set and the pump pauses (the pump may be configured with additional confirmation screens, requiring confirmation of all settings again before beginning the infusion).
5. Prior to connecting to the patient, press  to initiate the priming sequence (page 57).

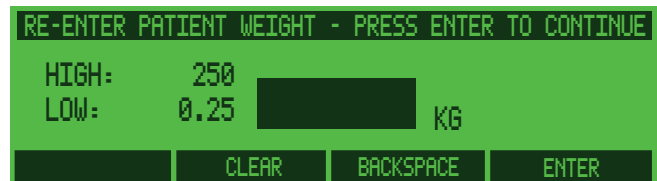

6. Confirm the settings and start the infusion, or use the four menu softkeys shown at right to modify the settings.

---

**WARNING: Confirm All Settings.** Before starting *any* delivery, *always* confirm the accuracy of *all* infusion values to the original order. Programming the pump at a delivery rate other than that prescribed will cause inappropriate delivery, which can result in serious injury or death.

---

7. When all delivery settings are confirmed as correct, press  to begin infusion.

PRESS < 4 > TO BEGIN INFUSION			
		PVD	0 mL
WEIGHT	5	KG	
DOSE	0.3	mL/KG/HR	RATE 1.5 mL/HR
MAIN MENU	CHG DOSE	OPTIONS	CLEAR TOTALS

**Main Menu** – returns to the **MAIN MENU**.

**Chg Dose** – allows modifying the set dosage without starting from scratch.

**Options** – allows selection from a list of variables (e.g., bolus, volume limit, etc.).

**Clear Totals** – clears total volume delivered, and PVD or PDD.

## Dose/kg/time (dose/m<sup>2</sup>/time)

The body weight/surface area infusion delivery mode **will only be available on a pump** through custom programming of a drug program via PharmGuard® Toolbox 2 (in other words, 'Dose/Kg/Time' and 'Dose/m<sup>2</sup>/Time' are never available as menu items, they must be utilized in the creation of a drug program, which is then sent to the pump). Once created using PharmGuard® Toolbox 2, taught to a Medfusion® Model 3500 pump V6, and once the drug program has been selected from the library, entries on the pump may be required for the following:

- **Drug selection only**
- **Drug concentration** (NOTE: If preset limits were programmed in PharmGuard® Toolbox 2, this option will be available. If a *preset value* was programmed in PharmGuard® Toolbox 2, the concentration limits are not needed.)

- **Patient's weight/Body surface area**
- **Dose**
- **Delivery time**

The pump calculates the correct flow rate in mL/hr to achieve the required drug dose. The patient weight/body surface area is used to calculate dose limits. To program a body weight/surface area infusion, choose a Drug Program with **DOSE/KG/TIME (DOSE/M<sup>2</sup>/TIME)**. Choose the syringe model and size, and load the syringe as instructed on page 32.

The following procedure is an example of how an infusion might be programmed. The actual procedure depends on how the infusion was initially customized.

1. Press the **number** keys to set medication concentration. Concentration is limited to 4 digits. Press **Clear** to clear an entry. Press **Backspace** to erase a character. Press **Enter** to accept the setting.
2. Press the **number** keys to set the patient's weight in kilograms or surface area in square meters. Weight/surface area are limited to the indicated range. Press **Enter** to accept the patient weight/surface area setting.

The pump may be customized with an additional patient weight/body surface area confirmation screen. If so, re-enter the patient weight/body surface area, then press **Enter** to accept the setting.

3. At the **DOSE** screen, press the **number** keys to set the dose. Dose limits displayed are dependant on custom settings and installed syringe size. When the setting is correct press **Enter** to accept the dose. (The pump calculates the correct flow rate in mL/hr to achieve the required drug dose.)

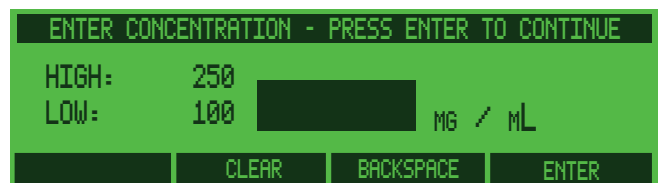

4. The time setting screen appears. Press the **number** keys to set the time in hours and minutes, then press **Enter**.
5. To confirm the setting, press **Yes**. To make changes before confirming, press **No**. At the **BEGIN INFUSION** screen all values are set and the pump pauses (the pump may be configured with additional confirmation screens, requiring confirmation of all settings again before beginning the infusion).
6. Prior to connecting to the patient, press  to initiate the priming sequence (page 57).
7. Confirm the settings and start the infusion, or use the menu softkeys shown at right to modify the settings.

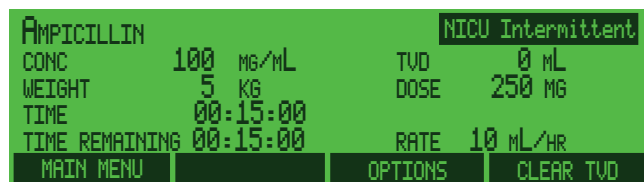
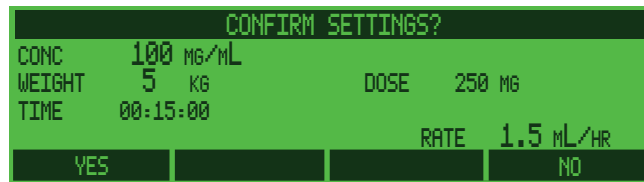

---

**WARNING: Confirm All Settings.** Before starting *any* delivery, *always* confirm the accuracy of *all* infusion values to the original order. Programming the pump at a delivery rate other than that prescribed will cause inappropriate delivery, which can result in serious injury or death.

---

8. When all delivery settings are confirmed as correct, press  to begin infusion.

**Main Menu** – returns to the **MAIN MENU**.

**Options** – allows selection from a list of variables (e.g., bolus, volume limit, etc.).

**Clear TVD** – clears total volume delivered.

## Volume / weight / time

The volume/weight/time delivery mode (**mL/KG/TIME**) may be available on a pump.

Volume/weight/time infusion rate calculations allow programming by:

- **Patient's weight**
- **Volume of drug per kilogram of weight**
- **Delivery time**

The pump calculates the correct flow rate in mL/hr to achieve the required drug dose. To program a volume/weight/time infusion, at the selection menu, choose **mL/KG/TIME** (or choose a drug program that uses the volume/weight/time mode infusion type). Choose the syringe model and size, and load the syringe as instructed on page 32.

1. Use the **number** keys to set the patient's weight in kilograms. Weight is limited to the indicated range. Press **Enter** to accept the patient weight setting.

The pump may be customized with an additional patient weight confirmation screen. If so, re-enter the patient weight, then press **Enter** to accept the setting.

2. At the **VOLUME/KILOGRAM** screen, press the **number** keys to set the volume per weight setting. Range limits here are determined by the installed syringe size, patient weight and/or the custom setup in the Configuration. When the setting is correct press **Enter** to accept it.
3. The time setting screen appears. Press the **number** keys to set the time in hours and minutes, then press **Enter**.
4. At the **BEGIN INFUSION** screen all values are set and the pump pauses (the pump may be configured with additional confirmation screens, requiring confirmation of all settings again before beginning the infusion).
5. Prior to connecting to the patient, press  to initiate the priming sequence (page 57).

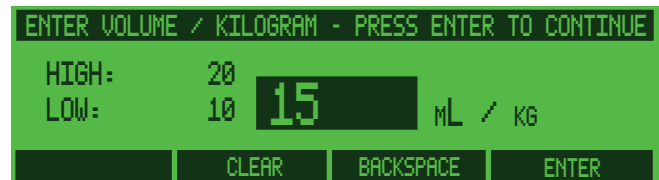



- Confirm the settings and start the infusion, or use the menu softkeys shown at right to modify the settings.

---

**WARNING: Confirm All Settings.** Before starting *any* delivery, *always* confirm the accuracy of *all* infusion values to the original order. Programming the pump at a delivery rate other than that prescribed will cause inappropriate delivery, which can result in serious injury or death.

---

- When all delivery settings are confirmed as correct, press  to begin infusion.

PRESS < 4 > TO BEGIN INFUSION			
WEIGHT	5 KG	PVD	0 ML
TIME:	00:30:00	VTBI	15 ML/KG
TIME REMAINING	00:30:00	RATE	150 ML/HR
MAIN MENU		OPTIONS	CLEAR TVD

**Main Menu** – returns to the **MAIN MENU**.

**Options** – allows selection from a list of variables (e.g., bolus, volume limit, etc.).

**Clear TVD** – clears total volume delivered.

## Volume / time

The volume over time rate calculation allows programming by:

- **Dose Volume**
- **Delivery Time**

The pump calculates the correct flow rate by dividing the volume by the delivery time. Volume limit, loading or bolus dose **cannot** be set in this mode.

To program Volume / Time, choose it at the selection menu (or choose a drug program that uses the volume/time mode infusion type). Choose the syringe model and size, and load the syringe as instructed on page 32.

1. Press the **number** keys to program the volume to infuse. Volume is limited to 500 mL – and minimum volume is 1/600<sup>th</sup> of the selected syringe size. When the Volume setting is correct, press **Enter**.

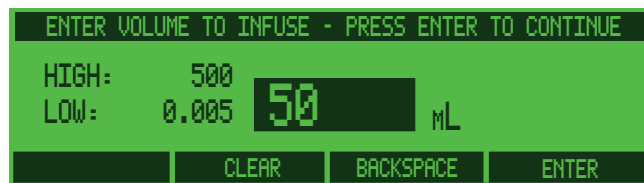

**Note:** Volume is limited to 500 mL regardless of syringe size in use, as some infusions may require multiple syringes.

2. Press the **number** keys to set delivery time. Time is always limited by maximum and minimum rates for selected syringe size and/or the custom setup in the Configuration. When the delivery time is correct, press **Enter**.
3. At the **BEGIN INFUSION** screen all values are set and the pump pauses (the pump may be configured with additional confirmation screens, requiring confirmation of all settings again before beginning the infusion).
4. Prior to connecting to the patient, press  to initiate the priming sequence (page 57).
5. Confirm the settings and start the infusion, or use the three menu softkeys to modify the settings.



**WARNING: Confirm All Settings.** Before starting **any** delivery, **always** confirm the accuracy of **all** infusion values to the original order. Programming the pump at a delivery rate other than that prescribed will cause inappropriate delivery, which can result in serious injury or death.

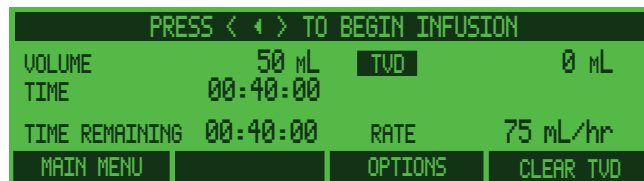

**Main Menu** – returns to the **MAIN MENU**.

**Options** – allows selection from a list of variables (e.g., standby, etc.).

**Clear TVD** – clears total volume delivered.

6. When all delivery settings are confirmed as correct, press  to begin infusion.

## Intermittent volume / time

*Intermittent Volume / Time* mode allows specification of a **delivery volume** for a **specific delivery time**, after which the delivery **stops** for a programmed interval, then the pattern recycles. In other words, the pump delivers for a set period, pauses a set period, then infuses for a set period, and so on.

- The *delivery stop interval* equals “Time Between Starts” minus “Delivery Time.”
- The pattern *repeats* at the “Time Between Starts” interval.

Below are the steps for programming an Intermittent Volume / Time infusion. Select **INTERMITTENT VOLUME / TIME** from the selection menu (or choose a drug program that uses the intermittent volume/ time mode infusion type). Choose the syringe model and size, and load the syringe as instructed on page 32.

1. Use the **number** keys to set the volume. Volume is limited to 500 mL, and minimum volume is 1/600<sup>th</sup> of syringe size. When the volume is correct, press **Enter**.

**Note:** Volume is limited to 500 mL regardless of syringe size in use, as some infusions may require multiple syringes.

2. Use the **number** keys to set the delivery time. Maximum and minimum times are calculated for the syringe in use and/or the custom setup in the Configuration. When ready, press **Enter**.
3. Use the **number** keys to set the time between starts value. Maximum and minimum times are calculated for the delivery time entered (minimum time must be at least one minute longer than the delivery time; the pump will not accept time between starts equal to or less than the delivery time). When ready, press **Enter**.
4. At the **BEGIN INFUSION** screen all values are set and the pump pauses (the pump may be configured with additional confirmation screens, requiring confirmation of all settings again before beginning the infusion).
5. Prior to connecting to the patient, press  to initiate the priming sequence (page 57).

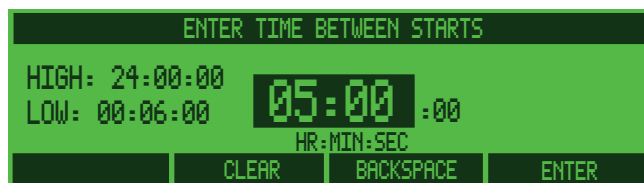
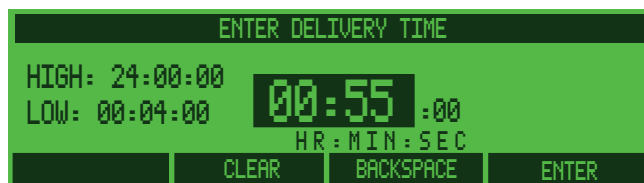
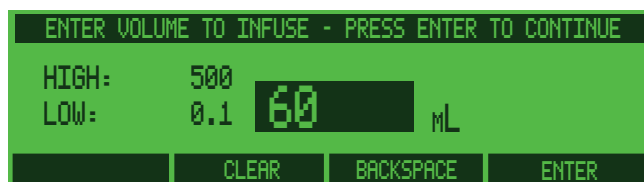

6. Confirm the settings and start the infusion, or use the three menu softkeys shown at right to modify the settings.

---

**WARNING: Confirm All Settings.** Before starting *any* delivery, *always* confirm the accuracy of *all* infusion values to the original order. Programming the pump at a delivery rate other than that prescribed will cause inappropriate delivery, which can result in serious injury or death.

---

7. When all delivery settings are confirmed as correct, press  to begin infusion.

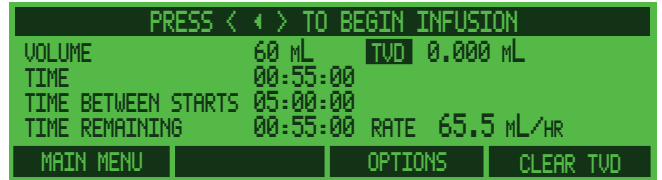

**Main Menu** – returns to the **MAIN MENU**.

**Options** – allows selection from a list of variables (e.g., standby, etc.).

**Clear TVD** – clears total volume delivered.

## Recall last settings

The Medfusion® Model 3500 pump V6 will recall the settings used to run the last infusion.

**Note:** If a pump has a custom configuration (created using PharmGuard® Toolbox 2 and taught to the pump) the *Recall last settings* feature is available only in those profiles it has been included in. **To use the feature, first enter the profile for the previous infusion.** Any optional Volume Limit, KVO, Bolus Dose or Loading Dose settings are retained in the infusion when this feature is used. All other options (Standby, Override Occl Limit, etc.) are discarded and

must be reprogrammed from the **OPTIONS** menu at the **BEGIN INFUSION** screen.

Reuse the same delivery settings to repeat an identical dosage of medication or fluids to a patient (choose the syringe model and size, and load the syringe as instructed on page 32):

1. Select **RECALL LAST SETTINGS** from the selection menu. (If it isn't shown, press the **More** key and search for it.) In this example, press the number 4.

When selected, press **Enter** to confirm the syringe type and size if the syringe has been replaced. After the syringe has been confirmed the **CONTINUE SAME INFUSION?** screen appears.

2. Prior to connecting to the patient, press  to initiate the priming sequence (page 57).

3. If **No** is pressed, the pump returns to the **MAIN** menu to select a different Drug Program or manual delivery mode.

If **Yes** is pressed, the pump pauses at the **BEGIN INFUSION** screen and PVD is *not* cleared. After reviewing these previously used settings, the pump pauses. To clear the TVD and PVD/PDD, press **Clear Totals**.

(For volume limited infusions, only the remaining volume specified will be delivered.)

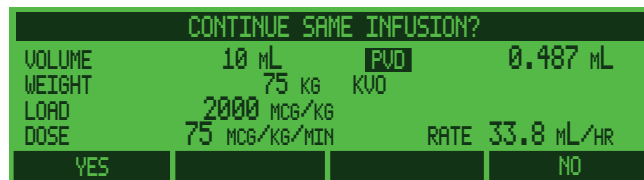
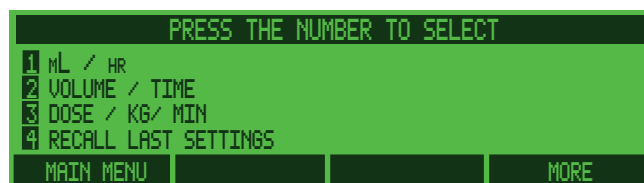

---

---

**WARNING: Confirm All Settings.** Before starting *any* delivery, *always* confirm the accuracy of *all* infusion values to the original order. Programming the pump at a delivery rate other than that prescribed will cause inappropriate delivery, which can result in serious injury or death.

---

---

4. When all delivery settings are confirmed as correct, press  to begin infusion. **Be sure all pump settings are correct before starting infusion.**



---

**TVD and PVD/PDD Retention:** The pump also retains TVD and PVD/PDD from the last infusion. If these values are not wanted, they must be manually cleared before beginning a new infusion.

---

## Priming the system

Priming is one of the functions of the **Bolus** key (  ). **Always prime a new syringe after loading it onto the pump and before connecting the tubing to the patient.** This removes the *mechanical slack* in the pump and syringe, and significantly reduces start-up time.



The priming sequence is extremely important to assure the accuracy of the delivery and reduce the start-up time. The priming sequence is performed after the infusion is programmed, and before delivery is started. The message at the top of the **BEGIN INFUSION** screen will alternate between “**PRESS <  > KEY TO BEGIN INFUSION**”, and “**PRESS <  > KEY TO PRIME**” as a reminder to perform the prime sequence.

### WARNINGS:

- **NEVER** prime any syringe while connected to a patient infusion site, as this may cause over-infusion which could result in serious injury or death.
- **To avoid air embolism**, always purge all air from syringe and infusion lines **before** connecting to the patient.
- Periodically check the fluid pathway and all connections (including the catheter/administration set connection) for leaks. Leaks in the system may cause fluid loss resulting in under-delivery, as well as allowing an opening for contamination.

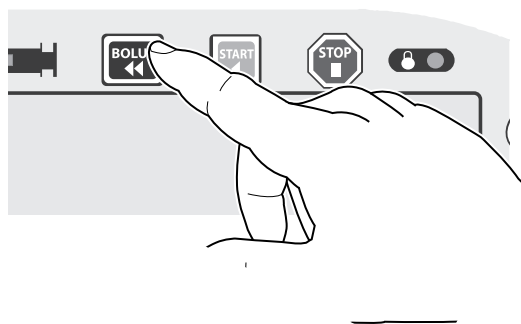
1. Press  to initiate priming.



2. The priming screen opens. To prime a loaded syringe, press and hold  while observing for fluid movement at the patient end of the system.
3. For safety reasons, priming stops as soon as the finger is lifted from  or after 15 seconds. To continue priming beyond the 15-second cutoff, release , then press & hold it again.

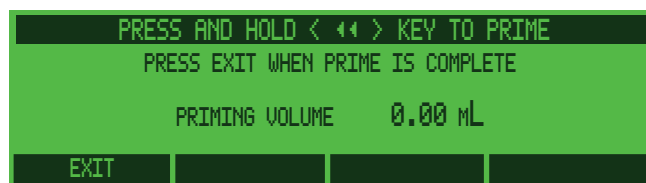

**Priming Volume Not Counted in TVD:** The total priming volume accumulates on screen, but is NOT counted in the Total Volume Delivered display. This is because the tubing is not connected to the patient during priming and therefore not delivered to the patient.

The Priming infusion rate is 300 mL/hr, or the default maximum bolus rate for the syringe size being used, whichever is lower.



---

---

**WARNING:** Once the syringe and tubing system is connected to the patient, raising the system above the patient (even briefly) can cause significant bolusing due to changes in hydrostatic pressure. Lowering the system below the patient (even briefly) can cause significant interruptions in flow due to changes in hydrostatic pressure. This could cause improper pump operation resulting in inaccurate fluid delivery that could result in serious injury or death. Place the pump as close to the patient's infusion site as possible.

---

---

Once the system is primed, connect the tubing to the patient and begin infusion.

## Options

**Options** gives access to program options that affect the *current infusion only*. The options available depend on the options that have been enabled for the profile and which have been customized for use using PharmGuard® Toolbox 2. Any options in use return to the default selection whenever the pump is turned off, or whenever the program is returned to the **MAIN** menu prior to beginning the next infusion.

In the case of the **RECALL LAST SETTINGS** feature (see page 55), programmed Options for Volume Limit, KVO, Bolus Dose or Loading Dose are retained when **RECALL LAST SETTINGS** is used. However options such as “Standby”, “Override Occl Limits”, etc. are discarded when the pump is turned off or when the program is returned to the **MAIN** menu, and would need to be reprogrammed at the **BEGIN INFUSION** screen, even if **RECALL LAST SETTINGS** was used to access that screen.

These options are available when the pump is at the **BEGIN INFUSION** screen (prior to starting an infusion):

- Override Occlusion Limit
- Override Alarm Loudness
- Disable/Enable Near Empty Alarm Tone
- Disable/Enable Volume Empty Alarm Tone
- Bolus Dose
- Delayed Start
- KVO
- Periodic Callback Alarm
- Change to Dose/Change to Volume
- Loading Dose
- Standby
- Volume Limit
- Disable/Enable FlowSentry™

These options are available when the pump is running an infusion:

- Bolus Dose
- Override Occlusion Limit
- Override Alarm Loudness
- Periodic Callback Alarm
- Disable/Enable Volume Empty Tone

- Disable/Enable Near Empty Tone
- Change to Dose/Change to Volume
- Disable/Enable FlowSentry™

---

**Note:** Customization settings in individual drug programs take priority over profile settings as to which options are available. For instance, while Bolus Dose and Loading Dose may be available as options in a given profile, individual drug programs within that profile may have these options disabled, and therefore they will not be available when using those specific drug programs.

---

## Bolus dosing

A *Bolus dose* is a separate delivery that pauses the main infusion, delivers the bolus (often at a different, higher rate), then returns to the main infusion when complete. It is an optional parameter of continuous delivery modes which allows a bolus volume or dose to be delivered over a specified time. Bolus dose may also be configured to be automatically “prompted” or included in the programming steps of a drug program.

A bolus may be programmed during the initial infusion setup, at the **BEGIN INFUSION** screen, or during an infusion without stopping medication delivery. If Bolus Autoprompt is set to **Enable** in PharmGuard® Toolbox 2, when initially programming a continuous infusion the bolus programming screens (steps 3-5, below) are part of the drug program setup. Pressing **Disable** at the bolus entry screen will disable the bolus feature for the *duration of the infusion*.

### Bolus programming

If programming a bolus at the **BEGIN INFUSION** screen or during an infusion:

1. Press **Options**.

2. Use the **number** keys to choose **BOLUS DOSE**.

Steps 3 through 5 are the bolus programming screens. If **Autoprompt** is **Enabled** in PharmGuard® Toolbox 2, they are part of the normal infusion programming workflow:

3. If the initial infusion is programmed in one of the body weight modes (e.g. Dose/Kg/Min), the bolus “dose” may be programmed in the parameters of that dose mode (e.g. Mg/Kg) or in Total Dose (e.g. Mg). Use the **number** keys to set the desired bolus dose for this infusion (or to set the dose volume in mL, if applicable for the infusion). Volume is limited by the maximum fill volume of the current syringe size, and minimum volume is 1/600<sup>th</sup> of the syringe size. When the dose setting (or bolus volume) is correct, press **Enter**.

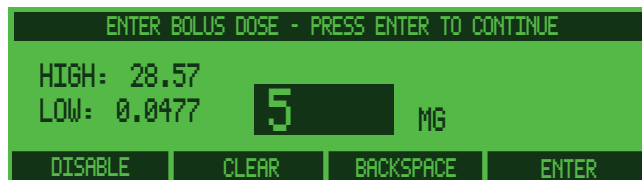
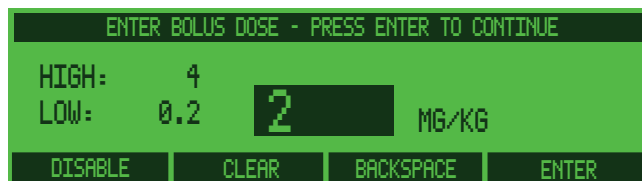
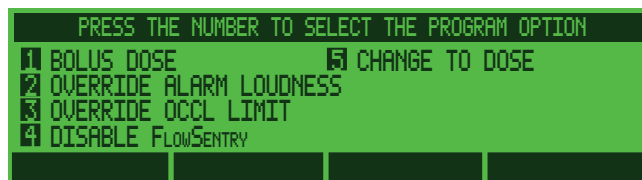
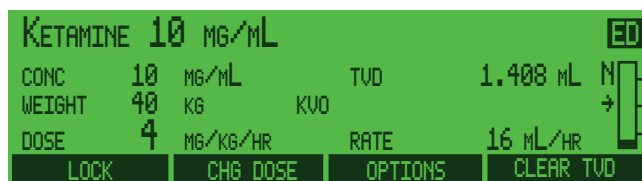
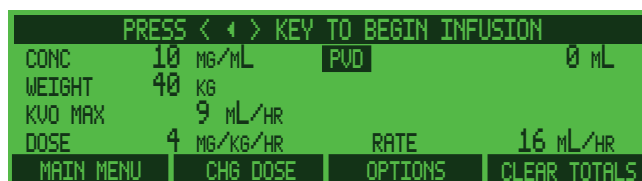

**Disable** – turns Bolus off for the duration of the infusion.  
**Clear** – deletes an entry. **Backspace** – erases a character.

4. Confirm that the bolus dose settings and total bolus dose are correct. If incorrect, press **No**, and the pump returns to the **ENTER BOLUS DOSE** screen. If correct, press **Yes**. Note that the bolus dose may be entered in dose/kg or Total Dose for weight-based modes (depending on pump customization). The confirmation screen highlights (in reverse) the value that the pump calculates.
5. Use the **number** keys to set bolus delivery time in minutes and seconds. The default value for bolus delivery rate can be set in custom configuration in PharmGuard® Toolbox 2, or if no default value is set, the pump defaults to the maximum bolus rate. Maximum & minimum time is calculated from the maximum & minimum rate for the syringe size currently in use and/or the custom setup in the Configuration. (If using a manual delivery mode and the Bolus Time feature has been disabled the pump will default to the maximum bolus rate.) When the bolus time is correct, press **Enter**.

Using PharmGuard® Toolbox 2, it is possible to restrict bolus time to minutes only. If that is the case the screen will look like this:

It is also possible to specify an absolute time limit using PharmGuard® Toolbox 2, in which case it cannot be changed.

---

**Note:** If the bolus is being programmed while an infusion is delivering, pressing **Enter** following time entry will cause the **BEGIN BOLUS DELIVERY?** screen to be displayed. See *Bolus Delivery* (starting at item 2 in the section that follows) for instructions on delivering the bolus.

---



## Bolus delivery

1. Press  (if necessary).

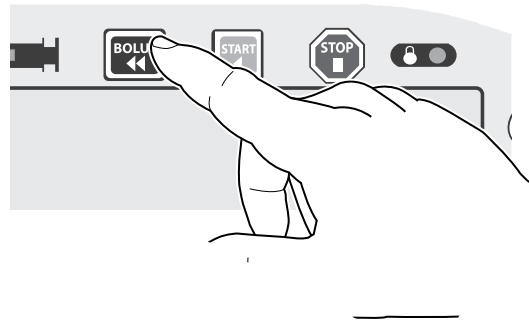

2. The **BEGIN BOLUS DELIVERY?** screen appears. To begin bolus delivery, press **Yes**. If bolus delivery is not desired right now, press **No**. To change the bolus amount, press **CHG Bolus** and reprogram the bolus (items 3 through 5 in the preceding section).

BEGIN BOLUS DELIVERY?			
BOLUS	2 MG/KG	VOLUME	8 mL
TIME	01:00 MM-SS	RATE	480 mL/HR
TOTAL BOLUS DOSE	80 MG		
YES		CHG BOLUS	NO

BEGIN BOLUS DELIVERY?			
BOLUS	2 MG/KG	VOLUME	8 mL
TIME	01:00 MM-SS	RATE	480 mL/HR
TOTAL BOLUS DOSE	80 MG		
YES		CHG BOLUS	NO

**WARNING: Confirm All Settings.** Before starting *any* delivery, *always* confirm the accuracy of *all* infusion values to the original order. Programming the pump at a delivery rate other than that prescribed will cause inappropriate delivery, which can result in serious injury or death.

3. If **Yes** was pressed, the **BOLUS DELIVERY** screen appears, with “**DELIVERING**” and the drug program name alternately appearing.

PRESS CANCEL TO STOP BOLUS DELIVERY			
DELIVERING			
BOLUS	2 MG/KG	DELIVERED	3.0760 mL
REMAINING	00:37 MM-SS		30.7600 MG
TOTAL BOLUS	80 MG	RATE	480 mL/HR
CANCEL			

**CANCEL** – stops the bolus and returns to the normal delivery rate and screen.

If **No** was pressed, the pump returns to the delivery screen. Note that the bolus information appears on the screen. Pressing  will cause the **BEGIN BOLUS DELIVERY?** screen to reappear, where bolus delivery can be started (see above).

KETAMINE 10 MG/ML				
CONC	10 MG/ML	TVD	31.338 mL	N →
WEIGHT	40 KG	KVO		
DOSE	4 MG/KG/HR	BOLUS	2 MG/ML	→
		RATE	16 mL/HR	
LOCK	CHG DOSE	OPTIONS	CLEAR TVD	

### Continuing an interrupted bolus dose

Should a **High Priority** alarm occur during bolus delivery, or if  or **Cancel** are pressed, the bolus stops. Either continue the bolus from where it left off, or cancel the bolus.

1. If necessary, press  to silence the alarm. Troubleshoot the alarm condition.

2. Press .

3. Either:
  - Press **Options**, then use the **number** keys to select **BOLUS DOSE**. **OR**
  - Press .

4. To continue the bolus from where it left off (delivering only what was remaining), press **Yes**.

Press **No** to exit the bolus screen, cancel bolus delivery and return to the main infusion.

OCCLUSION - CHECK INFUSION LINE			
KETAMINE 10 MG/ML			
BOLUS	2 MG/KG	DELIVERED	1.7770 ML
REMAINING	02:52 MM-SS		17.7700 MG
TOTAL BOLUS	80 MG	RATE	130 ML/HR
CANCEL			

KETAMINE 10 MG/ML			
CONC	10 MG/ML	TVD	1.639 ML
WEIGHT	40 KG	KVO	
DOSE	4 MG/KG/HR	BOLUS RATE	2 MG/ML 16 ML/HR
LOCK	CHG DOSE	OPTIONS	CLEAR TVD

PRESS THE NUMBER TO SELECT THE PROGRAM OPTION	
1 BOLUS DOSE	5 CHANGE TO DOSE
2 OVERRIDE ALARM LOUDNESS	
3 OVERRIDE OCCL LIMIT	
4 DISABLE FLOWSENTRY	

CONTINUE SAME BOLUS?			
BOLUS	2 MG/KG	DELIVERED	1.7770 ML
REMAINING	02:52 MM-SS		17.7700 MG
TOTAL BOLUS	80 MG	RATE	130 ML/HR
YES			NO

## Bolus dose rate reduction

The increased delivery rate of a bolus dose may trigger an occlusion alarm (depending on the occlusion limit settings in the pump and the resistance in the line). If this occurs, the bolus time is automatically increased by 30%, thus reducing the bolus rate. The bolus rate continues to be reduced and the bolus time increased until resistance is below the set occlusion limit.

If the rate reductions cannot succeed in delivering the bolus without occlusion occurring (if the bolus rate reduces below the infusion rate, or the bolus time increases past the maximum bolus time), the bolus is eventually cancelled.

There could be a variety of reasons for occlusions to occur, including (but not limited to) the occlusion limit in use, fluid/medication viscosity, tubing size, the patient's infusion site setup, etc.

1. Press  to silence the alarm. (**Bolus delivery continues at the reduced rate.**)

The pump continues to monitor the infusion and may reduce the rate multiple times (only the first alarm produces an audible tone - if the first alarm is silenced, additional rate reductions will not cause an audible tone to sound, however the amber (yellow) LED and the alarm message will display and can be cleared by pressing .

- If the rate reductions succeed in allowing the bolus to be delivered, the new, reduced rate (and bolus time) will become the set rate for boluses in that infusion. In other words, when a bolus is **Continued** or another bolus is initiated during the same infusion, or if the **RECALL LAST SETTINGS** feature is used (see page 55), the reduced rate will continue to be applied. If desired, use the **CHG Bolus** key on the **BEGIN BOLUS DELIVERY?** screen to alter the rate (for example, decrease bolus Dose and/or increase bolus Time).
2. If, however, the bolus rate reduces below the infusion rate, or the bolus time increases

RESTRICTED FLOW - RATE REDUCED			
DELIVERING			
BOLUS	2 MG/ML	DELIVERED	5.7200 ML
REMAINING	06:40 MM:SS		57.2000 MG
		RATE	130 ML/HR
CANCEL			

**CANCEL** – stops the bolus and returns to the normal delivery rate and screen.

BEGIN BOLUS DELIVERY?			
BOLUS	2 MG/KG	VOLUME	8 ML
TIME	29:50 MM:SS	RATE	16.1 ML/HR
TOTAL BOLUS DOSE	80 MG		
YES		CHG BOLUS	NO



past the maximum bolus time, the bolus is **cancelled**.

- Press  to silence the alarm. **The normal infusion delivery is continued.**

Determine the reason the bolus was unable to be delivered before re-attempting a bolus. Once the reason for the bolus cancellation is cleared, bolus delivery may be re-initiated (if desired). Unless the bolus settings are reprogrammed (either by entering the **Options** menu and reprogramming the bolus Dose and/or Time, or by pressing the **CHG Bolus** key at the **BEGIN BOLUS DELIVERY?** screen and reprogramming the bolus Dose and/or Time), the last bolus rate setting from just prior to the bolus cancellation will continue to be applied. Reprogram the bolus, if desired.

RESTRICTED FLOW - BOLUS CANCELLED			
CONC	10	MG/ML	PVD 12.763 ML
WEIGHT	40	KG	
KVO MAX	9	ML/HR	BOLUS 2 MG/ML
DOSE	4	MG/KG/HR	RATE 16 ML/HR
MAIN MENU	CHG DOSE	OPTIONS	CLEAR TOTALS

BEGIN BOLUS DELIVERY?			
BOLUS	2	MG/KG	VOLUME 8 ML
TIME	29:54	MM-SS	RATE 16.1 ML/HR
TOTAL BOLUS DOSE	80	MG	
YES		CHG BOLUS	NO

## Loading doses

A *loading dose* is a separate, specified volume (or dose) of drug infused as a one-time-only bolus (often at a different, higher rate) prior to the start of normal delivery. It is an optional parameter of continuous delivery modes which allows a bolus volume or dose to be delivered over a specified time. A loading dose may also be configured to be automatically “prompted” or included in the programming steps of a drug program.

A loading dose may be programmed at the **BEGIN INFUSION** screen by pressing **Options**. If Loading Dose Autoprompt is set to **Enable** in PharmGuard® Toolbox 2, when initially programming a continuous infusion the loading dose programming screens (steps 3-5, below) are part of the drug program setup. Pressing **Disable** at the loading dose entry screen will disable the feature for the *duration of the infusion*.

### Set up loading dose

If programming a loading dose at the **BEGIN INFUSION** screen:

1. Set the delivery mode parameters. When the pump is paused at the **BEGIN INFUSION** screen, press **Options**.
2. Use the **number** keys to choose **LOADING DOSE**. (You may have to press **More** to see this option.)
3. If the initial infusion is programmed in one of the body weight modes (e.g. Dose/Kg/Min), the loading “dose” may be programmed in the parameters of that dose mode (e.g. Mcg/Kg) or in Total Dose (e.g. Mg). Use the **number** keys to set the desired loading dose for this infusion (or to set the dose volume in mL, if applicable for the infusion). Volume is limited by the maximum fill volume of the current syringe size, and minimum volume is 1/600<sup>th</sup> of the syringe size. When the loading dose setting (or volume) is correct, press **Enter**.
4. Confirm that the loading dose settings and total loading dose are correct. If incorrect, press **No**, and the pump returns to the **ENTER LOADING DOSE** screen. If correct, press **Yes**. Note that the bolus dose may be entered in dose/kg or Total Dose for weight-based modes (depending on pump customization). The confirmation screen highlights (in reverse) the value that the pump calculates.

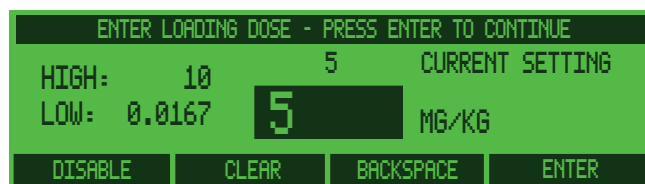
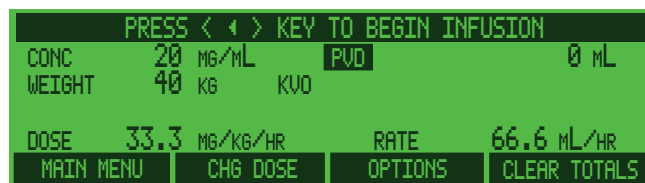

**Disable** – turns Bolus off for the duration of the infusion.  
**Clear** – deletes an entry. **Backspace** – erases a character.



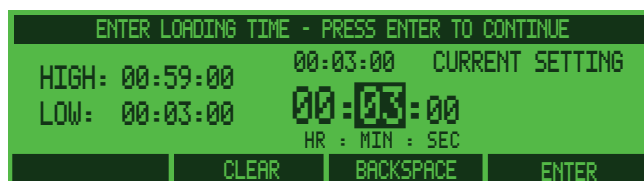

- Use the **number** keys to set delivery time in minutes & seconds. The default value for loading (i.e., bolus) delivery rate is set in custom configuration. Maximum & minimum time is calculated from the maximum & minimum rate for the syringe size currently in use (or maximum and minimum can be set using PharmGuard® Toolbox 2).

Using PharmGuard® Toolbox 2, it is possible to restrict loading time to minutes only. If that is the case the screen will look like this:

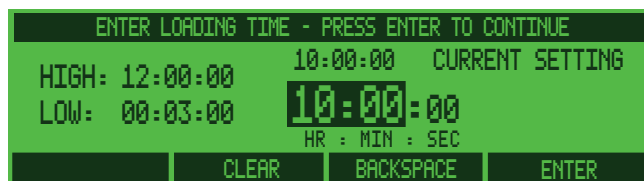

Using PharmGuard® Toolbox 2, it is also possible to expand loading time to up to 12 hours. If that is the case the screen will look like this:



- After the loading dose is set and accepted, the pump pauses. The Loading Dose setting now appears on the **BEGIN INFUSION** screen. If this is a new infusion, prior to connecting to the patient press  to initiate the priming sequence (page 57).

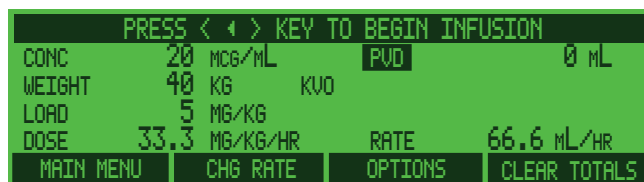



---

**WARNING: Confirm All Settings.** Before starting *any* delivery, *always* confirm the accuracy of *all* infusion values to the original order. Programming the pump at a delivery rate other than that prescribed will cause inappropriate delivery, which can result in serious injury or death.

---

## Delivering a loading dose

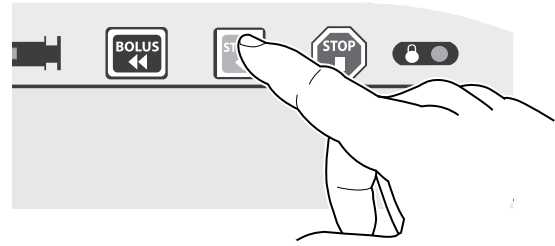
1. When ready, press .



2. The **BEGIN LOADING DOSE** screen appears. Depending on which mode the pump is delivering in, the screen is slightly different.
3. To begin delivering the loading dose, press **Yes**. **OR**
  - Press **No** to skip the loading dose and return to the normal delivery screen. **OR**
  - Press **Chg Dose** to change the loading dose settings.
  - If enabled in PharmGuard® Toolbox 2 and if the loading dose settings have been programmed in body weight, the key labeled **Chg In mL** will allow the dose to be changed in mL directly (if enabled).

BEGIN LOADING DOSE DELIVERY?			
LOAD	5 MG/KG		
TIME	03:00 MM-SS	RATE	200 mL/HR
TOTAL LOADING DOSE		200	MG
YES		CHG DOSE	NO

BEGIN LOADING DOSE DELIVERY?			
LOAD	5 MG/KG		
TIME	03:00 MM-SS	RATE	200 mL/HR
TOTAL LOADING DOSE		200	MG
YES		CHG DOSE	NO

**Note:** If no keys are pressed for 30 seconds, the User Callback alarm will sound.

4. If **Yes** was pressed, the **LOADING DOSE DELIVERY** screen appears and the infusion begins, with “**DELIVERING**” and the drug program name alternately appearing.

The pump delivers the loading dose then automatically switches to the normal delivery rate and screen. The loading dose volume delivered is automatically added to the Total Volume Delivered (TVD) as well as the Programmed Volume Delivered (PVD), or Programmed Dose Delivered (PDD) for that infusion.

PRESS CANCEL TO STOP LOADING DOSE DELIVERY DELIVERING			
LOAD	5 MG/KG	DELIVERED	0.9550 mL
REMAINING	02:42 MIN-SS		19.1000 MCG
TOTAL LOAD	200 MG	RATE	200 mL/HR
CANCEL			

**CANCEL** – stops the loading dose and returns to the normal delivery rate and screen.

### Continuing an interrupted loading dose

Should a **High Priority** alarm occur during loading dose delivery, or if  or **Cancel** are pressed, the dose stops. Either continue the dose from where it left off, or cancel the dose.

1. If necessary, press  to silence the alarm. Troubleshoot the alarm condition.

OCCLUSION - CHECK INFUSION LINE			
	AMINOCAPROIC ACID DRIP 20 MG/ML		
LOAD	5 MG/KG	DELIVERED	4.0040 ML
REMAINING	05:07 MM:SS		80.0800 MG
TOTAL LOAD	200 MG	RATE	70.2 ML/HR
CANCEL			

2. Press .
3. To continue the loading dose from where it left off (delivering only what was remaining), press **Yes**.

Press **No** to cancel the remainder of the loading dose and begin the main infusion.

CONTINUE SAME LOAD?			
BOLUS	5 MG/KG	DELIVERED	4.0040 ML
REMAINING	05:07 MM:SS		80.0800 MG
TOTAL BOLUS	200 MG	RATE	70.2 ML/HR
YES		NO	

## Loading dose rate reduction

The increased delivery rate of a loading dose may trigger an occlusion alarm (depending on the occlusion limit settings in the pump and the resistance in the line). If this occurs, the loading time is automatically increased by 30%, thus reducing the loading rate. The loading rate continues to be reduced and the loading time increased until resistance is below the set occlusion limit.

If the rate reductions cannot succeed in delivering the loading dose without occlusion occurring (if the loading rate reduces below the infusion rate, or the time increases past the maximum loading time), the loading dose is eventually cancelled.

There could be a variety of reasons for occlusions to occur, including (but not limited to) the occlusion limit in use, fluid/medication viscosity, tubing size, the patient's infusion site setup, etc.

1. Press  to silence the alarm. (**Loading Dose delivery continues at the reduced rate.**)



The pump continues to monitor the infusion and may reduce the rate multiple times (only the first alarm produces an audible tone - if the first alarm is silenced, additional rate reductions will not cause an audible tone to sound, however the amber (yellow) LED and the alarm message will display and can be cleared by pressing .

- If the rate reductions succeed in allowing the loading dose to be delivered, the new, reduced rate (and loading time) will become the set rate for the loading dose in that infusion. In other words, when a loading dose is **Continued** (if delivery is stopped for any reason while the loading dose is being delivered), or if the **RECALL LAST SETTINGS** feature is used (see page 55), the reduced rate will continue to be applied. See item 2 on the next page for instructions on altering the reduced rate, if desired.

RESTRICTED FLOW - RATE REDUCED			
DELIVERING			
LOAD	5 MG/KG	DELIVERED	4.8940 mL
REMAINING	02:35 MIN-SS		97.8799 MG
TOTAL LOAD	200 MG	RATE	118 mL/HR
CANCEL			

**CANCEL** – stops the loading dose and returns to the normal delivery rate and screen.

2. If, however, the loading dose rate reduces below the infusion rate, or the dose time increases past the maximum loading dose time, the loading dose is **cancelled**. Delivery stops.

- Press  to silence the alarm. Determine the reason the loading dose was unable to be delivered before re-attempting a loading dose. Once the reason for the cancellation is cleared, loading dose delivery may be re-initiated (if desired). Unless the loading dose settings are reprogrammed, the last loading dose rate setting from just prior to cancellation will continue to be applied. Reprogram the loading dose, if desired.
- From the **CONTINUE SAME LOAD?** screen, to continue delivering the loading dose at the new, reduced rate, press **Yes**. To alter the rate, press **No**, press  to stop the normal infusion, then enter the **OPTIONS** menu to reprogram the Loading Dose (this method restarts the infusion from the beginning, so you may need to manually subtract any loading dose delivered prior to the cancellation from the amount programmed).
- If **RECALL LAST SETTINGS** is used, when  is pressed the **BEGIN LOADING DOSE DELIVERY?** screen appears with the new, reduced rate. If desired, use the **CHG Dose** key to alter the rate (for example, decrease loading Dose and/or increase loading Time).

RESTRICTED FLOW - LOADING CANCELLED			
	AMINOCAPROIC ACID DRIP	20 MG/ML	
LOAD	5 MG/KG	DELIVERED	4.9690 ML
REMAINING	08:28 MM:SS		99.3799 MG
TOTAL LOAD	200 MG	RATE	70.2 ML/HR
CANCEL			

CONTINUE SAME LOAD?			
	5 MG/KG	DELIVERED	4.9690 ML
BOLUS			
REMAINING	08:28 MM:SS		99.3799 MG
TOTAL BOLUS	200 MG	RATE	70.2 ML/HR
YES		NO	

BEGIN LOADING DOSE DELIVERY?			
LOAD	5 MG/KG		
TIME	08:33 MM:SS	RATE	70.2 ML/HR
TOTAL LOADING DOSE	200 MG		
YES		CHG DOSE	NO



## Volume limit

A *Volume Limit* is an **Option** available for *continuous delivery modes*. On reaching the preset volume limit, the pump stops – or changes to KVO if a keep vein open rate has been programmed.

Volume limit is based on the amount of programmed volume that is delivered.

**Enable / Disable Volume Limit:** If *Volume Limit* is not currently available as a dosing option, it can be enabled through custom pump configuration (using PharmGuard® Toolbox 2).

### Setting volume limit

A volume limit can be set either before starting an infusion or by pausing the pump during an infusion. Volume limit is found in the **OPTIONS** menu, which can be accessed from the **BEGIN INFUSION** screen.

1. With the pump stopped, press **Options**.
2. Use the **number** key to select **VOLUME LIMIT**.
3. Use the **number** keys to set the volume limit, then press **Enter**.

**Note:** Volume is limited to 500 mL regardless of syringe size in use, as some infusions may require multiple syringes.

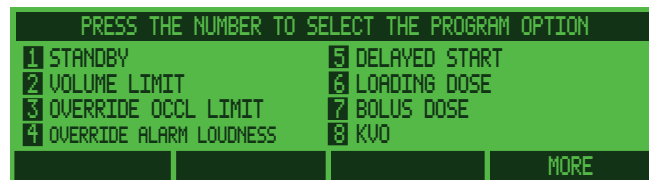
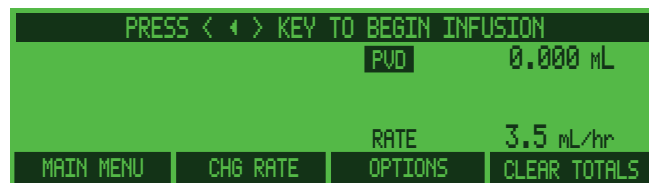

**Disable** – turns Volume Limit off. **CLEAR** – deletes an entry. **Backspace** – erases a character.

4. The volume limit setting now appears on the display. Program Volume Delivered (PVD) will appear on the screen directly above the **V LIMIT**.
5. If this is a new infusion, prior to connecting to the patient press  to initiate the priming sequence (page 57).

PRESS < ◀ ▶ > KEY TO BEGIN INFUSION			
	PVD	0.000 mL	
	V LIMIT	50 mL	
	RATE	3.5 mL/HR	
MAIN MENU	CHG RATE	OPTIONS	CLEAR TOTALS

---

**WARNING: Confirm All Settings.** Before starting *any* delivery, *always* confirm the accuracy of *all* infusion values to the original order. Programming the pump at a delivery rate other than that prescribed will cause inappropriate delivery, which can result in serious injury or death.

---

6. Press  to begin infusion. The infusion will automatically stop when it reaches the preset volume limit.

## Keep Vein Open (KVO) rate

The *Keep Vein Open* (KVO) rate is an **Option** available for continuous delivery modes.

The *keep vein open* feature is intended for use when delivering a series of infusions to a patient, and the delivery site must remain *patent* between the end of one infusion and the beginning of the next.

- A *volume limit* must be programmed for KVO to work. After a volume limit is reached, a low rate (KVO) is set to maintain patency of the infusion site.
- The range of rates available appears on the **ENTER KVO RATE** screen. KVO rates are calculated by syringe size and its minimum flow rate.
- The programmed KVO rate must be *less than* the normal delivery rate and *greater than or equal to* minimum flow rate for the syringe.

**Once the volume limit has been reached, the pump will begin infusing at either the programmed KVO rate or the current infusion rate, which ever is less.**

A KVO rate can be set at the **BEGIN INFUSION** screen before starting an infusion or by pausing the pump during an infusion. KVO can also be programmed as part of the drug program using PharmGuard® Toolbox 2.

**Note:** The setting of KVO rates should be based on a physician's order or the facility's policies and procedures for rate determination.



**Enable / Disable KVO Rate:** KVO rate can be enabled or disabled through custom pump configuration (using PharmGuard® Toolbox 2).

### Programming KVO rate

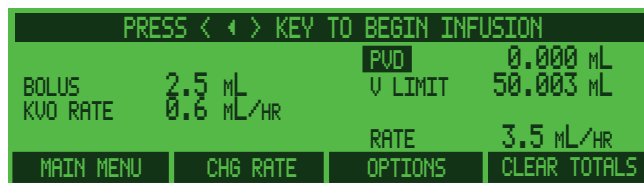
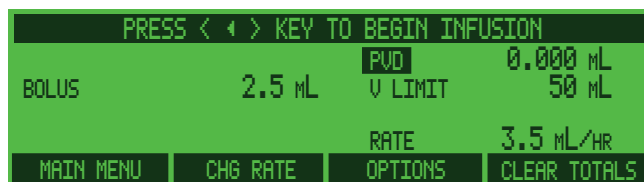
1. With the pump stopped, press **Options**.
2. Use the **number** keys to choose **KVO**.
3. Use the **number** keys to set the KVO rate within the minimum and maximum rates on screen. When the KVO rate is set, press **Enter**.
4. The KVO setting now appears on the screen.
5. If this is a new infusion, prior to connecting to the patient press  to initiate the priming sequence (page 57).



**WARNING: Confirm All Settings.** Before starting *any* delivery, *always* confirm the accuracy of *all* infusion values to the original order. Programming the pump at a delivery rate other than that prescribed will cause inappropriate delivery, which can result in serious injury or death.

6. Press  to begin infusion.
7. When the infusion reaches the programmed volume limit, rather than stopping delivery, the pump automatically begins delivery at the KVO rate (or continues at the current rate if less than the KVO rate) and triggers an alarm.
8. KVO delivery automatically stops when the pump calculates the syringe is empty, or if  is pressed. When the pump automatically stops keep vein open infusion, it sounds a “syringe empty” alarm.

**Stop KVO Infusion:** Stop a KVO infusion at any time by pressing .

**Silence KVO Alarm:** Silence the alarm by pressing .



## Standby

*Standby* is an **Option** that allows the pump to remain at the **BEGIN INFUSION** screen without the *User Callback* alarm sounding for the Standby period.

- The pump **does not automatically start** an infusion at the end of the standby.
- Instead, the pump triggers an alarm at the end of the standby period.

**Enable / Disable Standby:** The *Standby* option can be enabled / disabled through custom configuration (using PharmGuard® Toolbox 2).

### Programming standby

1. When the pump is paused at the **BEGIN INFUSION** screen, press **Options**.
2. Use the **number** keys to choose **STANDBY**.
3. Set the Standby time in hours & minutes. The maximum Standby setting is 24 hours. The default Standby time is 1:00 Hr. When the Standby time is correct, press **Enter** to accept the setting and go to the **BEGIN INFUSION** screen.
4. The Standby timer then appears in the upper right corner on screen “counting down” alternately with “**PRESS < 1 > To BEGIN INFUSION**” and the Drug Program name. The *User Callback* alarm is disabled for this interval. Standby continues until the timer has counted to zero. Standby can be discontinued at any time by pressing **START**, when **Main Menu** is pressed to return to the **MAIN** menu, or by setting Standby to zero.
5. If this is a new infusion, prior to connecting to the patient press **BOLUS** to initiate the priming sequence (page 57).

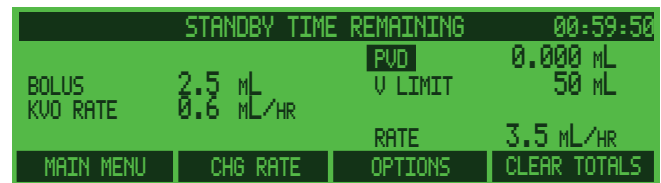
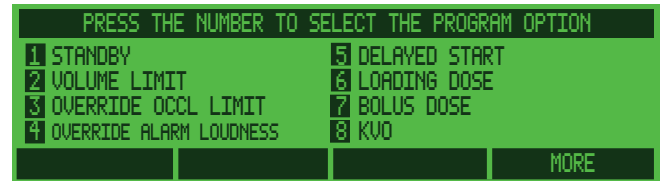

6. When the counter reaches zero, the pump sounds an alarm as a reminder to begin the infusion.

---

---

**WARNING: Confirm All Settings.** Before starting *any* delivery, *always* confirm the accuracy of *all* infusion values to the original order. Programming the pump at a delivery rate other than that prescribed will cause inappropriate delivery, which can result in serious injury or death.

---

---

## Delayed start

*Delayed Start* is an **Option** that allows the pump to remain at the **BEGIN INFUSION** screen without the *User Callback* alarm sounding for the specified period, then **automatically** starts the infusion at the end of the Delayed Start period.

**Enable / Disable Delayed Start:** The *Delayed Start* option can be enabled / disabled through custom configuration (using PharmGuard® Toolbox 2).

### Programming delayed start

- When the pump is paused at the **BEGIN INFUSION** screen, press **Options**.
- Use the **number** keys to choose **DELAYED START**.
- Set the Delayed Start time in hours & minutes. The maximum Delayed Start setting is 6 hours. The default Delayed Start time is 1:00 Hr. When Delayed Start is correct, press **Enter** to accept the setting and go to the **BEGIN INFUSION** screen.
- The Delayed Start timer then appears in the upper right corner on screen “counting down” alternately with “**PRESS < 4 > KEY TO START INFUSION IMMEDIATELY**” and the Drug Program name. The *User Callback* alarm is disabled for this interval. Delayed Start continues until the timer has counted to zero. Delayed Start can be discontinued at any time by pressing **START**, or by setting Delayed Start to zero.
- If this is a new infusion, prior to connecting to the patient press **BOLUS** to initiate the priming sequence (page 57).

**WARNING: Confirm All Settings.** Before starting *any* delivery, **always** confirm the accuracy of *all* infusion values to the original order. Programming the pump at a delivery rate other than that prescribed will cause inappropriate delivery, which can result in serious injury or death.

- When the counter reaches zero, the pump **automatically begins the infusion**.

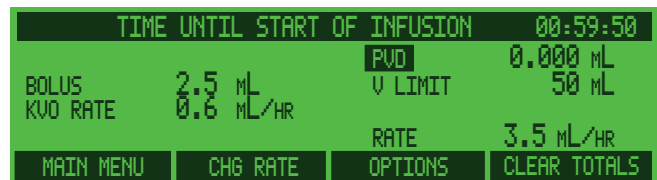
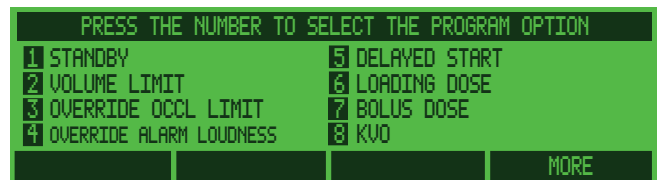
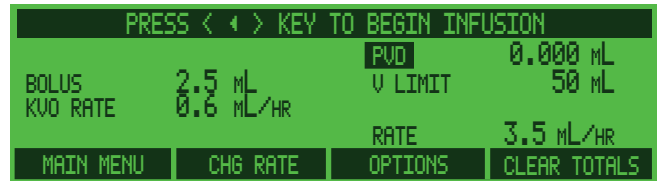

## Periodic callback alarm

The Periodic callback alarm is an **Option** that causes an alarm to be generated at a programmed period of time.

**Note:** During delivery of a loading dose, bolus dose, or flush delivery, the periodic callback timer is suspended, then restarts once the optional delivery is complete. For example, if a periodic callback is set for 1 hour, then a bolus dose is delivered which lasts 10 minutes, the periodic callback will actually occur at 1 hour and 10 minutes.

**Enable / Disable Periodic Callback Alarm:** The *Periodic Callback Alarm* option can be enabled / disabled through custom configuration (using PharmGuard® Toolbox 2).

### Programming periodic callback alarm

1. With the pump delivering an infusion or paused, press **Options**.
2. Use the **number** keys to choose **PERIODIC CALLBACK ALARM**. (You may need to press **More** to see it.)
3. Set the callback alarm time in hours & minutes. The maximum callback time is 8 hours. The default callback time is 2:00 Hr. When the callback time is correct, press **Enter** to accept the setting and go to the **BEGIN INFUSION** screen.
4. If this is a new infusion, prior to connecting to the patient press **BOLUS** to initiate the priming sequence (page 57).

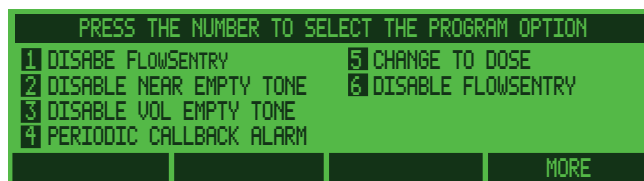
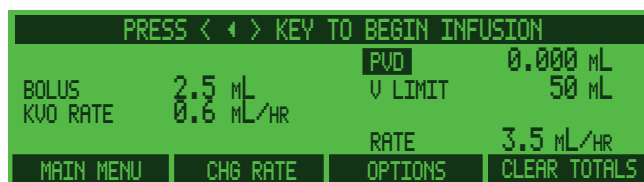

**WARNING: Confirm All Settings.** Before starting *any* delivery, *always* confirm the accuracy of *all* infusion values to the original order. Programming the pump at a delivery rate other than that prescribed will cause inappropriate delivery, which can result in serious injury or death.



5. When ready, press  to begin infusion.

Once the infusion starts, the Periodic Callback Alarm sounds a *Medium* priority alarm at the time interval programmed.

The Periodic Callback Alarm can be discontinued at any time by changing the Periodic Callback Alarm time to zero.



## Override and toggle features

When the pump is paused at the **BEGIN INFUSION** screen (or, in some cases while infusing), pressing **Options** provides access to several override and toggle options that will affect the current infusion **only**.

These **Options** will return to the default selection whenever the pump is turned off, or whenever the program is returned to the **MAIN** menu prior to beginning the next infusion.

### Change to Dose / Change to Volume

When delivering a drug program or infusion containing a concentration (must be a “continuous” style infusion), you may want to view either the volume delivered (PVD) or the dose delivered (PDD). The toggle PVD / PDD option may be used at the **BEGIN INFUSION** screen, or during an infusion without stopping medication delivery.

1. With the pump at the **BEGIN INFUSION** screen (or during medication delivery), press **Options**.
2. Use the **number** keys to choose **CHANGE TO DOSE** or **CHANGE TO VOLUME** (only one or the other will be shown, depending on the current setting). (You may have to press **More** to see this option.)
3. PVD will change to PDD (or vice-versa, depending on the current setting). See page 96 for more information on PVD/PDD.

PVD (Program Volume Delivered) indicates **Volume** is currently selected

PRESS < 4 > KEY TO BEGIN INFUSION			
CONC	1.5 MG/ML	<b>PVD</b>	0 ML
WEIGHT	5 KG	DOSE	20 MG
TIME	02:00:00		
TIME REMAINING	02:00:00	RATE	6.67 ML/HR
MAIN MENU	CHG DOSE	OPTIONS	CLEAR TOTALS

PRESS THE NUMBER TO SELECT THE PROGRAM OPTION			
1	BOLUS DOSE	5	OVERRIDE OCCL LIMIT
2	PERIODIC CALLBACK ALARM	6	CHANGE TO DOSE
3	OVERRIDE ALARM LOUDNESS	7	VOLUME LIMIT
4	DELAYED START	8	DISABLE FLOWSENTRY
			MORE

PDD (Program Dose Delivered) indicates **Dose** is currently selected

PRESS < 4 > KEY TO BEGIN INFUSION			
CONC	1.5 MG/ML	<b>PDD</b>	0 MCG
WEIGHT	5 KG	DOSE	20 MG
TIME	02:00:00		
TIME REMAINING	02:00:00	RATE	6.67 ML/HR
MAIN MENU	CHG DOSE	OPTIONS	CLEAR TOTALS

## Override occlusion limit

The pump's programmed default occlusion setting can be overridden. This allows setting a higher or lower occlusion limit for a specific infusion.

**Note:** When a 1mL syringe is entered into the programming, the occlusion pressure setting is **fixed** at *very high* (50psi), meaning there is no option of changing it.

1. Set the delivery mode parameters. When the pump is paused at the **BEGIN INFUSION** screen, press **Options**.
2. Use the **number** keys to choose **OVERRIDE OCCL LIMIT**. (You may have to press **More** to see this option.)
3. The *highlight* shows the pump's current default setting. Use the **number** keys to choose the desired occlusion setting, then press **Enter** (see the table on page 92 for more information about occlusion settings).

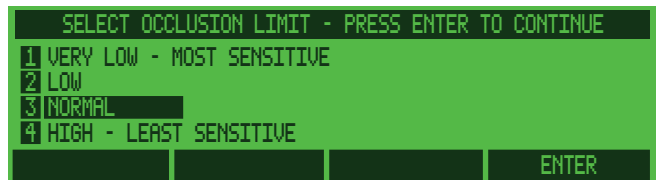
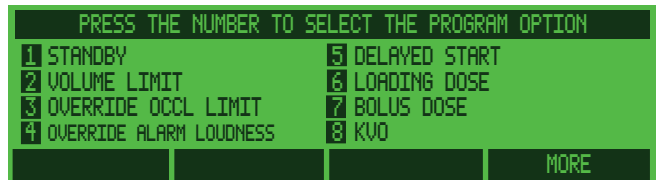
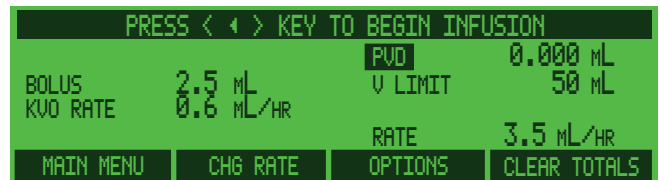

## Override alarm loudness

Occasionally it may be necessary to change the loudness of the audible alarm. For instance, if the infusion is taking place in an area with a lot of ambient room noise the loudest alarm setting may be wanted. The alarm loudness can be set from Level 1 (quietest) to Level 5 (loudest), however it cannot be disabled or completely silenced.

1. With the pump running or stopped, press **Options**.
2. Use the **number** keys to choose **VERRIDE ALARM LOUDNESS**. (You may have to press **More** to see this option.)
3. The *highlight* shows the pump's current default setting. Use the **number** keys to choose the desired alarm loudness setting, then press **Enter**.  
To determine which setting meets the needs for the infusion, use the **number** key to choose a loudness level then press **Test**.

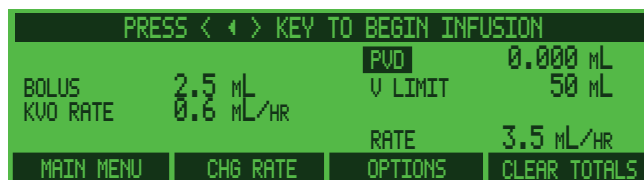

## Disable/enable FlowSentry™ pressure monitoring

The pump has an internal program for rapid occlusion detection called FlowSentry™ pressure monitoring. The pump may have been configured to either turn this feature on or off. To change the default setting for a specific infusion, use this option.

**Note:** With certain syringes, such as those for enteral delivery, FlowSentry™ pressure monitoring is automatically disabled and cannot be enabled.

1. With the pump running or stopped, press **Options**.
2. Use the **number** keys to choose **DISABLE FLOWSENTRY** or **ENABLE FLOWSENTRY** (only one of the above will be displayed, depending on whether the rapid occlusion detection feature is currently active or not). (You may have to press **More** to see this option.)

PRESS < ◀ ▶ > KEY TO BEGIN INFUSION			
BOLUS	2.5 mL	PVD	0.000 mL
KVO RATE	0.6 mL/HR	V LIMIT	50 mL
		RATE	3.5 mL/HR
MAIN MENU	CHG RATE	OPTIONS	CLEAR TOTALS

PRESS THE NUMBER TO SELECT THE PROGRAM OPTION			
1	DISABLE FLOWSENTRY		
2	DISABLE NEAR EMPTY TONE		
3	DISABLE VOL EMPTY TONE		
			BEGINNING

## Disable/enable near empty alarm tone

The pump may be configured to have an alarm sound to indicate when a syringe is *nearly* empty. (Alarm triggering is calculated based on the syringe size used and the volume initially calculated; see page 101 for an explanation of this alarm.) Use this option to enable or disable this feature for this infusion.

1. With the pump running or stopped, press **Options**.
2. Use the **number** keys to choose **DISABLE NEAR EMPTY TONE** or **ENABLE NEAR EMPTY TONE** (only one of the above will be displayed, depending on whether the Near Empty Alarm feature is currently active or not). (You may have to press **More** to see this option.)

PRESS < ◀ ▶ > KEY TO BEGIN INFUSION			
BOLUS	2.5 mL	PVD	0.000 mL
KVO RATE	0.6 mL/HR	V LIMIT	50 mL
		RATE	3.5 mL/HR
MAIN MENU	CHG RATE	OPTIONS	CLEAR TOTALS

PRESS THE NUMBER TO SELECT THE PROGRAM OPTION			
1	DISABLE FLOWSENTRY		
2	DISABLE NEAR EMPTY TONE		
3	DISABLE VOL EMPTY TONE		
			BEGINNING

## Disable/enable vol empty alarm tone

The pump may be configured to have an alarm sound to indicate when the volume of medication in a syringe is near empty. (The calculation for *when* the alarm sounds is based on the syringe size used and the volume initially programmed.) Use this option to enable or disable this feature for this infusion.

1. With the pump running or stopped, press **Options**.
2. Use the **number** keys to choose **DISABLE VOL EMPTY TONE** or **ENABLE VOL EMPTY TONE** (only one of the above will be displayed, depending on whether the Empty Alarm feature is currently active or not). (You may have to press **More** to see this option.)

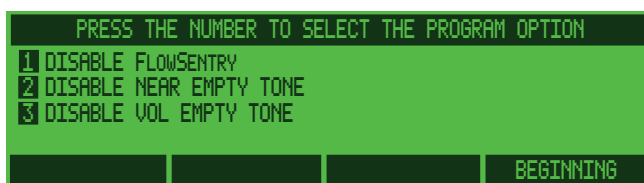
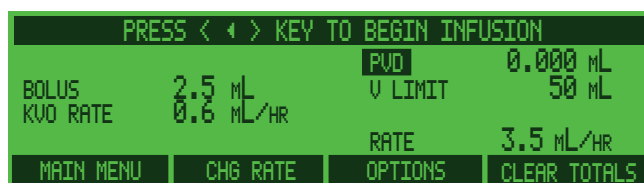

# Infusion Delivery

## Starting & stopping infusion delivery

An infusion delivery can be started at any time after a delivery mode has been set up. An infusion can be started from a pause, standby, or delayed start screen. **Prior to connecting the tubing to the patient and starting an infusion, press  to initiate the priming sequence** (page 57).

**WARNING: Confirm All Settings.** Before starting *any* delivery, *always* confirm the accuracy of *all* infusion values to the original order. Programming the pump at a delivery rate other than that prescribed will cause inappropriate delivery, which can result in serious injury or death.

### Start delivery from pause

Whenever beginning an infusion setup and progressing all the way through the setup levels, the pump *pauses* at the **BEGIN INFUSION** screen.

1. Program an infusion.
2. Verify all values are correct.
  
3. Press .
4. The pump begins the infusion.

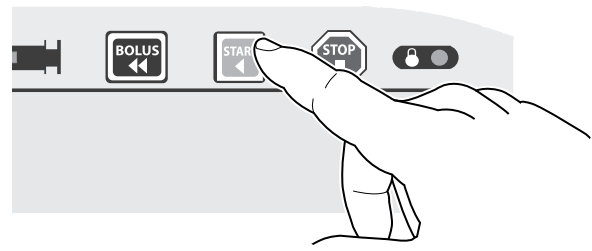
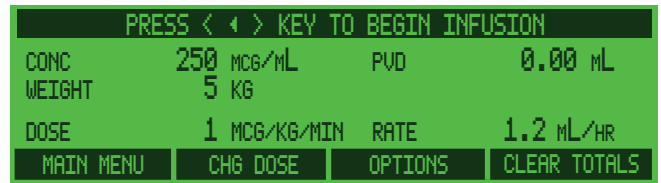

## Starting delivery from standby or delayed start

Start the infusion at **any time** when the pump is on standby or delayed start. It is unnecessary to either cancel standby or wait until the standby period ends.

1. To start infusion from standby or delayed start, press .
2. Before starting the infusion, you may also:
  - a) Return to the **MAIN** menu.
  - b) Change the Rate (or Dose).
  - c) Change delivery options, such as volume limit or bolus dose.
  - d) Clear Totals.

TIME UNTIL START OF INFUSION		00:59:50	
BOLUS	2.5 mL	PVD	0.000 mL
KVO RATE	0.6 mL/HR	V LIMIT	50 mL
		RATE	3.5 mL/HR
MAIN MENU	CHG RATE	OPTIONS	CLEAR TOTALS

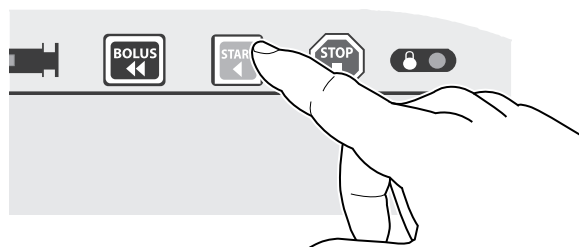

## Stopping delivery

An infusion can be stopped at **any time**, in any delivery mode.

1. If there is an active alarm, first silence it. Then, press .
2. The infusing indicators turn off and the pump pauses. Restart the infusion, or change settings and restart. Or, turn the pump off.

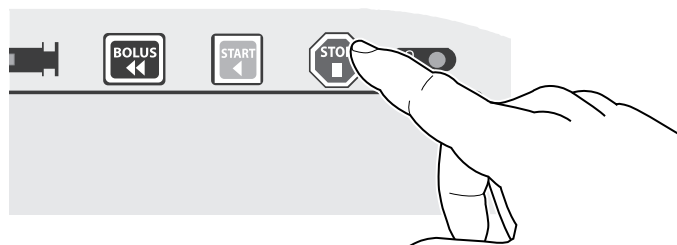

## Continuing interrupted delivery

An infusion can be continued from where it left off should it be interrupted for any reason.

1. If there is an active alarm, first silence it. Then, press .
2. To continue the infusion, press **Yes**. Press **No** to cancel the remainder of the infusion and return to the **MAIN** menu.

CONTINUE SAME INFUSION?			
BOLUS	2.5 mL	PVD	0.000 mL
KVO RATE	0.6 mL/HR	V LIMIT	50 mL
		RATE	3.5 mL/HR
YES			NO



## Flush feature

Some medications and infusions may require flushing the line to remove any residual medication or infusate. Using PharmGuard® Toolbox 2, this feature can be enabled for certain profiles, facilitating the pump to automatically prompt flushing the tubing when an infusion is complete. The pump may prompt to set a delivery time for the flush, or only to specify a volume (depending on how the feature is

enabled). This feature is only available if enabled for intermittent (timed) infusions (for example, Dose/kg/Time, Volume/Time, mL/Kg/Time, etc.), and is not available for continuous infusions. Depending on the pump's custom configuration, a volume limit may have been set in the drug program using PharmGuard® Toolbox 2.

### Volume only

- When the programmed infusion is complete or the **SYRINGE EMPTY** alarm activates and the pump alarms, press .
- The **BEGIN FLUSH SETUP** screen appears. If flush is not desired at this point, press **No** (the pump will return to the **BEGIN INFUSION** screen). To begin the flush setup, press **Yes**.
- Remove the syringe at the end of the infusion when prompted and replace with the flush syringe. Use the **number** key to select the syringe model.
- Load the syringe onto the pump, verify the correct size is shown, then press **Enter**.
- Use the **number** keys to enter the desired amount of flushing infusate, then press **Enter**. Volume is limited by the size of the syringe being used, and may also be limited by any custom configuration settings.
- To begin flush delivery, press **Confirm**. **OR**
  - Press **Chg Vol** to return to the **FLUSH VOLUME** screen and change the volume.
  - OR**
  - Press **Main Menu** (or **Quick Library**) to skip the flush delivery and return to the **MAIN** menu.

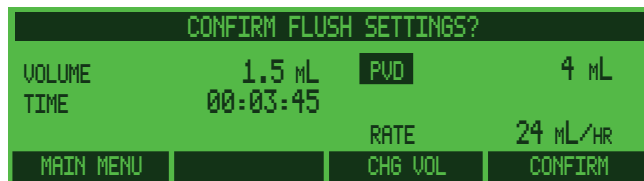
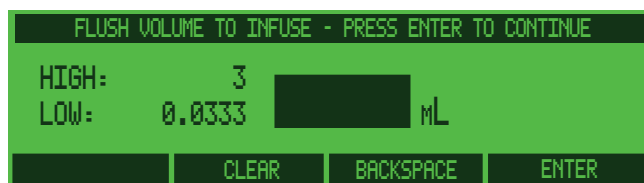

**Note:** If no keys are pressed for 30 seconds, the *User Callback* alarm will sound.

- When **Confirm** is pressed, the flush infusion begins delivering, with “**FLUSHING**” and the drug program name alternately appearing. The flush is calculated to deliver at the same rate as the previous infusion.

To cancel or stop the delivery, press . If flush delivery is cancelled/stopped, or should an alarm interrupt flush delivery, It can be restarted (see below).

- When the flush infusion has been delivered, delivery stops and the pump alarms. Press  to silence the alarm, then press **Main Menu**.

PRESS < ■ > TO STOP FLUSH DELIVERY			
FLUSHING			
FLUSH VOLUME	1.5 mL	FLUSHED	0.140 mL
TIME	00:03:45		
REMAINING	00:03:22	RATE	24 mL/HR

FLUSH STOPPED - PRESS < ◀ > KEY TO CONTINUE			
PVD			
FLUSH VOLUME	1.5 mL		4.140 mL
TIME	00:03:45		
REMAINING	00:03:22	RATE	24 mL/HR
YES			NO

INFUSION COMPLETE			
PVD			
VOLUME	1.5 mL		5.5 mL
TIME	00:03:45		
REMAINING	00:00:00	RATE	24 mL/HR
MAIN MENU			

### Continuing an interrupted flush infusion

Should a **High Priority** alarm occur during flush infusion delivery, or if  is pressed to interrupt a flush infusion, delivery will stop. Either continue the flush from where it left off, restart a new flush, or cancel the flush.

- If necessary, press  to silence the alarm. Troubleshoot the alarm condition.

OCCLUSION - CHECK INFUSION LINE			
FLUSH VOLUME	1.5 mL	FLUSHED	0.151 mL
TIME	00:03:45		
REMAINING	00:03:21	RATE	24 mL/HR
CANCEL			

- Press .

FLUSH STOPPED - PRESS < ◀ > KEY TO CONTINUE			
PVD			
FLUSH VOLUME	1.5 mL		4.151 mL
TIME	00:03:45		
REMAINING	00:03:21	RATE	24 mL/HR
YES			NO

- To continue the flush infusion from where it left off (delivering only what was remaining), press **Yes**.

Press **No** to cancel the remainder of the flush infusion and return to the **MAIN** menu.

CONTINUE SAME FLUSH?			
PVD			
FLUSH VOLUME	1.5 mL	FLUSHED	0.151 mL
TIME	00:03:45		
REMAINING	00:03:21	RATE	24 mL/HR
YES			NO

## Volume and time

- When the programmed infusion is complete or the **SYRINGE EMPTY** alarm activates and the pump alarms, press .
- The **BEGIN FLUSH SETUP** screen appears. If flush is not desired at this point, press **No** (the pump will return to the **BEGIN INFUSION** screen). To begin the flush setup, press **Yes**.
- Remove the syringe at the end of the infusion when prompted and replace with the flush syringe. Use the **number** key to select the syringe model.
- Load the syringe onto the pump, verify the correct size is shown, then press **Enter**.
- Use the **number** keys to enter the desired amount of flushing infusate, then press **Enter**.
- The pump requires confirmation that the flush be delivered at the same rate as the previous infusion. To deliver at the same rate, press **Yes** (the pump will then automatically calculate the delivery time). To deliver at a different rate, press **No**.
- If **No** was pressed, the **FLUSH TIME** screen appears. Use the **number** keys to select the delivery time, then press **Enter**.

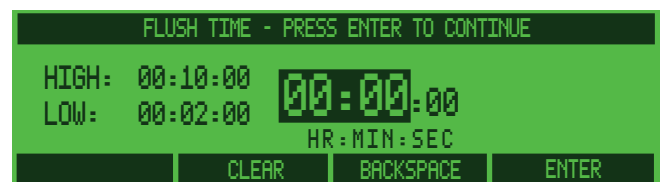
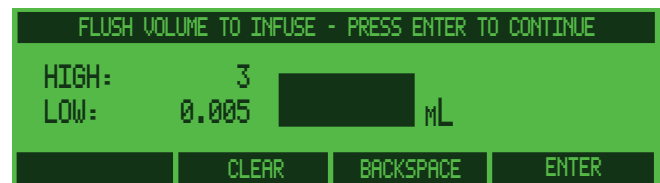
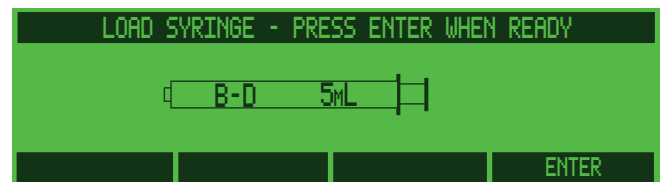
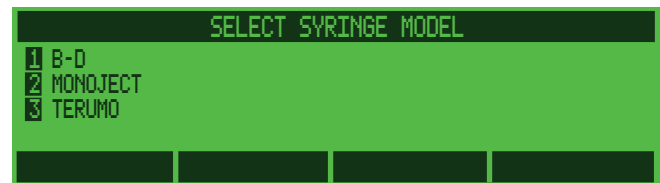
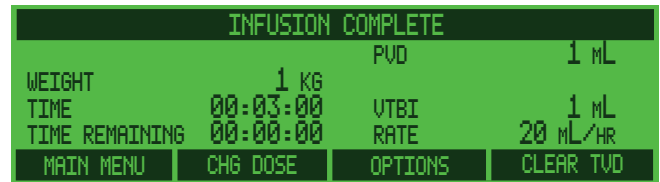

8. To begin flush delivery, press **Confirm**. **OR**
  - Press **Chg Vol** to return to the **FLUSH VOLUME** screen and change the volume. **OR**
  - Press **Chg Time** to return to the **FLUSH TIME** screen and change the time. **OR**
  - Press **Main Menu** (or *Quick Library*) to skip the flush delivery and return to the **MAIN** menu.

**Note:** If no keys are pressed for 30 seconds, the *User Callback* alarm will sound.

9. When **Confirm** is pressed the flush infusion begins delivering, with “**FLUSHING**” and the drug program name alternately appearing.

To cancel the flush, press **Cancel**. If flush delivery is cancelled, or should an alarm interrupt flush delivery, it can be restarted by pressing **Flush** (or if finished press **Main Menu** (or *Quick Library*) to exit).

10. When the flush infusion has been delivered, delivery stops and the pump alarms. Press  to silence the alarm, then press **Main Menu**.

CONFIRM FLUSH SETTINGS?			
FLUSH VOLUME	1.5 mL		
TIME	00:04:30		
		RATE	20 mL/HR
MAIN MENU	CHG TIME	CHG VOL	CONFIRM

PRESS CANCEL TO STOP FLUSH DELIVERY			
FLUSHING			
FLUSH VOLUME	1.5 mL	FLUSHED	0.02 mL
TIME	00:04:30		
REMAINING	00:04:21	RATE	20 mL/HR
CANCEL			

FLUSH STOPPED			
FLUSH VOLUME	1.5 mL	FLUSHED	0.02 mL
TIME	00:04:30		
REMAINING	00:03:22	RATE	20 mL/HR
MAIN MENU	FLUSH		

INFUSION COMPLETE			
FLUSH VOLUME	1.5 mL	FLUSHED	1.50 mL
TIME	00:04:30		
REMAINING	00:00:00	RATE	20 mL/HR
MAIN MENU			

## Time to occlusion

The time for the pump to detect an occlusion is affected by three factors:

1. *Occlusion Pressure Setting* – High (H), Normal (N), Low (L), or Very Low (VL).
2. *Flow Rate Setting*.
3. *Syringe & Tubing Compliance*, (i.e., softness of syringe plunger tip or tubing).

Reference page 122 for time-to-occlusion specifications. See guidelines for pump performance on time to occlusion. At lower rates smaller syringes have shorter occlusion times, which is why the smallest available syringe for the volume to be delivered should always be used.

## Occlusion trend graph during delivery

The pump automatically monitors *occlusion* or syringe backpressure during any infusion. This trend appears in a *bar graph* on the right side of the display during delivery. The letter at the top of the graph indicates the configured occlusion alarm level:

Code	Meaning	Relative Pressure
VH	Very High ( <b>fixed</b> for 1 mL syringes)	50 psi (345 kPa)
H	High	16 psi (110 kPa)
N	Normal	12 psi (83 kPa)
L	Low	8 psi (55 kPa)
VL	Very Low	4 psi (28 kPa)

The pressure graph is scaled between 0 psi at the bottom and the Occlusion setting pressure at the top. The occlusion limit can be set from Very Low to High for syringes with a volume greater than 1 mL. The occlusion limit is a fixed value for 1 mL syringes. The setting for 1 mL syringes is fixed at 50 psi, meaning the setting cannot be changed. The reason for this is that at lower pressure settings occlusion alarms would be frequent.

Pressures in the above table are only approximations. This is because syringe friction affects the actual pressure level.

Occlusion limit default is set up using PharmGuard® Toolbox 2, which was completed by the person responsible for custom Configuration before the

pumps were delivered to a work area.

Override the default Occlusion limit for a particular infusion from the **OPTIONS** menu if that option is enabled.

The pump takes the pressure measurement approximately every second:

- The **right side** of the bar is the most current reading.
- The **middle bar** is the 1 minute average.
- The **far left bar** is the 2 minute average.

Therefore:

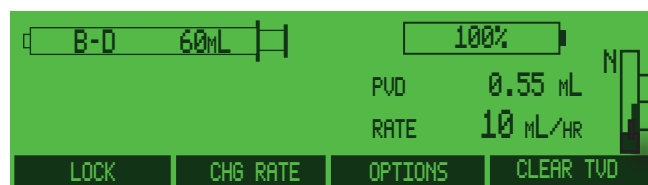

- If the graph slopes upward from left to right, then the pump may be headed toward occlusion.

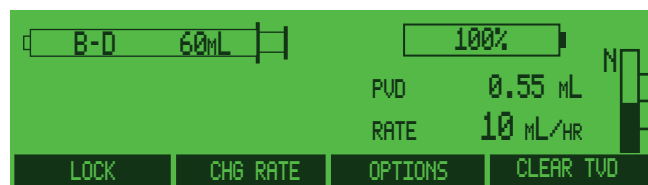

- If the graph is level, then backpressure is steady.

## FlowSentry™ pressure monitoring (rapid occlusion detection)

FlowSentry™ pressure monitoring is an internal program unique to Medfusion® pumps that monitors and analyzes delivery pressure. When activated, FlowSentry™ pressure monitoring alerts to the existence of an occlusion much more rapidly than conventional occlusion alarm systems. The sensitivity of the FlowSentry™ pressure monitoring setting is determined by the selection in the custom Configuration, using PharmGuard® Toolbox 2.

### How do you know if FlowSentry™ pressure monitoring has been activated?

- During startup and during the stabilization period following a rate change a pound sign (#) will appear to the left of the pressure trend graph. The presence of the # indicates that FlowSentry™ pressure monitoring is active, and that the

delivery pressure is stabilizing.

**Note:** FlowSentry™ pressure monitoring is disabled at rates greater than roughly 1/3 of the syringe size per hour. See the table at right for more information.

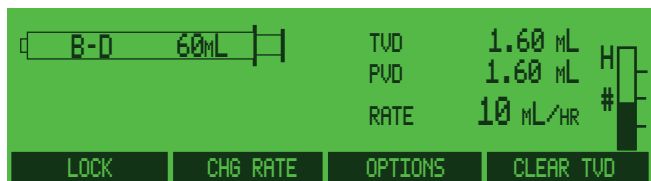

- Once the delivery pressure has reached a stable level the # sign will be replaced by a horizontal arrow (→).

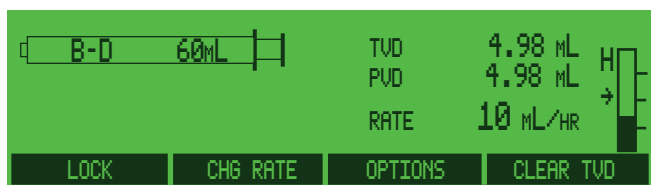

- If there is an increase in the delivery pressure the horizontal arrow will be replaced by a vertical arrow (↑).

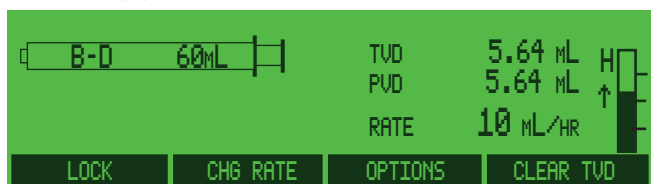

In this way it can easily be seen that a) FlowSentry™ pressure monitoring is activated, and b) whether the delivery pressure is stabilizing, steady, or increasing. In the event that the FlowSentry™ pressure monitoring has not been activated there will be no # or arrow signs to the left of the pressure trend graph.

FlowSentry™ pressure monitoring is automatically disabled when the delivery rate for a syringe size is exceeded as indicated in the following table:

Syringe Size	FlowSentry™ maximum infusion rate
60 mL	20 mL/hr
50 mL	20 mL/hr
35 mL	12 mL/hr
30 mL	10 mL/hr
20 mL	6.6 mL/hr
12 mL	3.3 mL/hr
10 mL	3.3 mL/hr
6 mL	1.65 mL/hr
5 mL	1.65 mL/hr
3 mL	1 mL/hr

If FlowSentry™ pressure monitoring is disabled, the bar graph is still shown, however none of the icons (#, → or ↑) will appear on screen.

### Post occlusion bolus reduction





With large syringes, fluid can accumulate or be “stored” in the line when an occlusion happens, which is then delivered as a bolus when the occlusion is released. This stored volume is the result of the volume of the syringe and infusion set increasing under pressure. The pump contains a feature for reducing this bolus upon occlusion release (or occlusion bolus).

Using post occlusion bolus reduction, the pump withdraws the plunger a predetermined amount to reduce “stored” bolus in the syringe. However, this feature does not totally eliminate the occlusion bolus. Occlusion bolus will vary greatly with occlusion limit setting, syringe size, and the fluid infused. The post-occlusion bolus reduction feature decreases bolus on occlusion release to less than 0.3 mL.

**WARNING:** Larger size syringes at occlusion setting HIGH may produce a post occlusion bolus larger than 0.3 mL due to excessive syringe plunger tip compliance.

## Making changes during delivery

At right is an illustration of a delivery screen. There are eight options available during any standard infusion. While running an infusion, you may:

- Lock/Unlock the keypad.
- Change the Dosage Rate.
- Select certain Program Options.
- Clear TVD
- Press  to set, change, or deliver a bolus.
- Press  to pause or end infusion delivery.
- Press  to begin pump shutdown.
- Press  to silence an alarm.

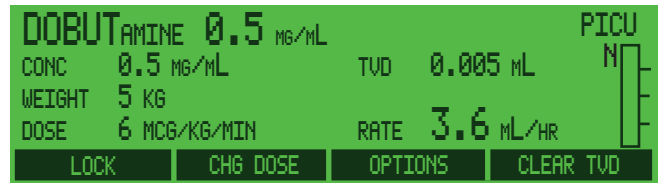

## Changing delivery rate

The Medfusion® Model 3500 pump V6 offers ways of changing delivery rate either before beginning an infusion, during delivery or when delivery is paused.

### Changing rate during delivery

The infusion rate can be changed during any delivery session, except when using Intermittent delivery modes.

1. From any delivery screen, press **CHG Rate** (or **CHG Dose**).
2. The **ENTER RATE** screen appears. **Infusion does not stop**. The current setting continues to be delivered until the new rate is **entered**. Note the current setting is always shown in the top of the display.
3. Use the **number** keys to set the dose rate. Rate is limited by the maximum and minimum delivery rate for syringe size.  
If rate change is not desired, press **BACK**. The delivery rate does not change until **Enter** is pressed.
4. When the desired rate is displayed press **Enter** to accept the new setting. (The new rate is not effective until **Enter** is pressed.)



### Changing the rate when paused

The dosage rate can be changed at any time the pump is paused:

1. With the pump paused at the **BEGIN INFUSION** screen, press **Chg Rate** (or **Chg Dose**).
2. Use the **number** keys to change the delivery rate. Rate is limited by the maximum and minimum delivery rate for syringe size, or by custom settings in the configuration. The delivery rate entry does not change until **Enter** is pressed. Exit without changing the rate by pressing **BACK**.
3. When the desired new rate is displayed press **Enter** to accept the new setting.
4. The pump is paused at the **BEGIN INFUSION** screen. When ready to restart the infusion, press **START**.

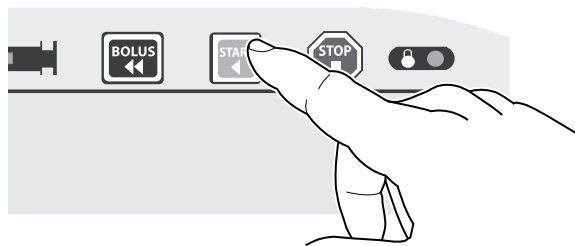
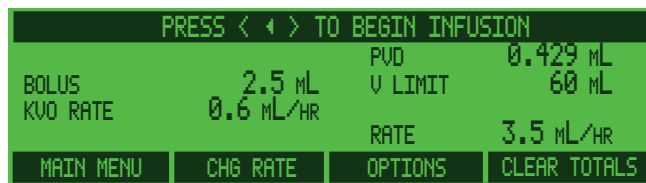



## Total volume, program volume / dose delivered

The Medfusion® Model 3500 pump V6 monitors and maintains the total quantity of fluids being delivered during any given session of infusions. Total Volume Delivered (TVD) is displayed at the top of the screen. The TVD is the total volume delivered to the patient, accumulated over multiple drug programs and infusions, and **it will continue to accumulate until Clear TVD (or Clear Totals) is pressed or the pump is turned off.**

TVD can be recalled using the Recall Last Settings feature (see page 55).

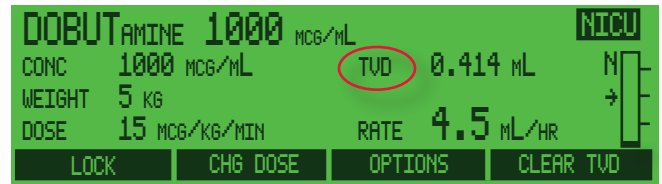

## Displaying “Program Volume Delivered” (PVD) / “Program Dose Delivered” (PDD)

In most delivery modes, there is the option of viewing either “Program Volume Delivered” or “Program Dose Delivered”.

On the display, PVD or PDD accumulates as the volume or dose is delivered to the patient, and accumulates **for the current infusion only**. PVD/PDD is automatically cleared when the infusion ends and the pump is returned to the **MAIN** menu, and can be cleared by pressing **Clear Totals**. This display totals the boluses, loading dose, and normal delivery volumes.

- **Priming volume** – Which should never be delivered to the patient – **does not** accumulate on this display.
- **Program volume or dose delivered** – Appears on screen while the pump is paused and during **DELIVERY** for the first three seconds and briefly by pressing **BACK**.
- **Program Dose Delivered** – Only available when concentration has been programmed.
- **Toggle from PVD to PDD** – Available through **OPTIONS** menu (provided this option has been enabled for use). See page 81 for instructions on using this option.

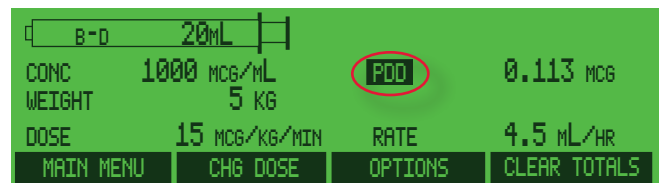
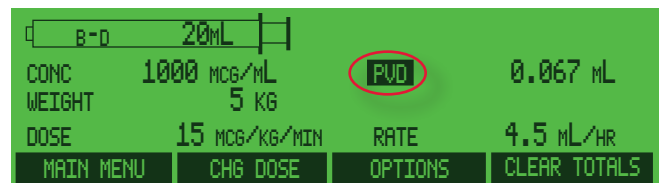

## Clearing total volume, program volume, or program dose delivered

Use the following steps to clear the total volume and program volume (or dose) and reset the counter to zero.

*With the pump paused (press , if necessary):*

1. Press **Clear Totals**.
2. Confirmation is required to clear totals delivered. Press **Yes** to clear total volume delivered and program volume (or dose) delivered. (Or press **No** to exit without clearing.)

The program volume (or dose) delivered is cleared automatically whenever the pump's delivery mode is changed or following the **INFUSION COMPLETE** alarm. The Total Volume Delivered is only cleared when the softkey is pressed (i.e., **Clear Totals** key).

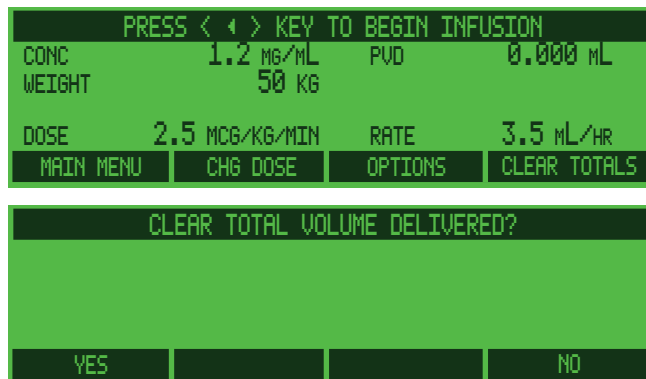

*With the pump delivering:*

1. From any run screen, press **Clear TVD**.
2. Confirmation is required to clear the Total Volume delivered. Press **Yes** to clear total volume delivered only. (Or press **No** to exit without clearing.)

The program volume (or dose) delivered is cleared automatically whenever the pump's delivery mode is changed or following the **INFUSION COMPLETE** alarm. The Total Volume Delivered is only cleared when the softkey is pressed (i.e., **Clear Totals** key).

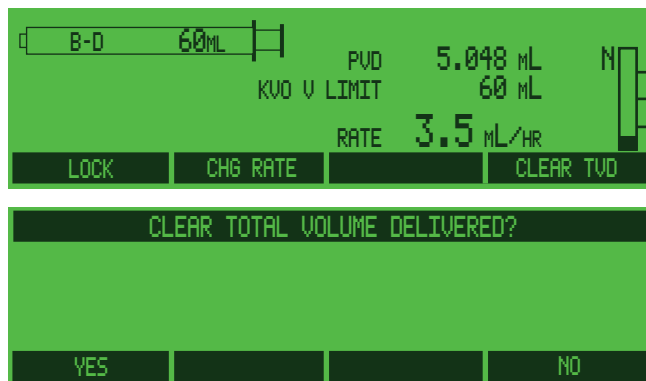

**Recovering TVD Information:** The Total volume delivered display can be restored after turning the pump off by using the *Recall Last Settings* selection from the **MAIN** menu. If TVD has been cleared, then only the quantity infused since clearing will be stored in memory. It may be good practice to make note of TVD before clearing it.

## Keypad lock

The keypad can be locked during delivery. The lock feature is provided to make the delivery settings tamper resistant.

Once the keypad is locked, a setting cannot be modified until the keypad is unlocked. The Medfusion® Model 3500 pump V6 offers a programmable unlock code option set through custom configuration. **Any high-priority alarm automatically unlocks the front panel.**

1. Press **Lock** to lock the front panel controls.

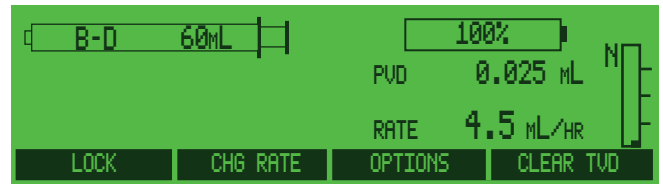

The LOCK indicator on the front panel lights.

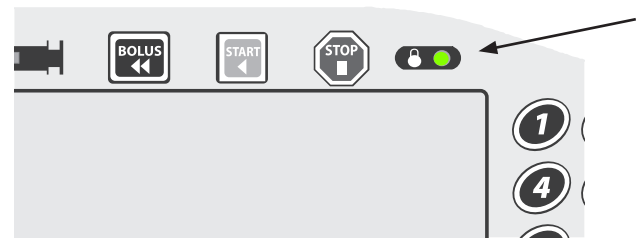

2. If any front panel keys other than **Unlock** are pressed, a “**PUMP IS LOCKED**” message appears on screen.

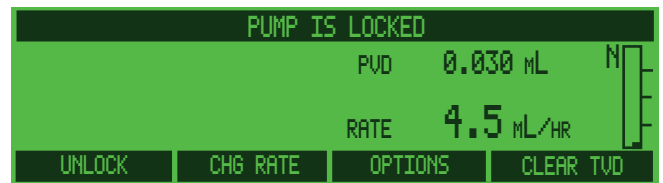

3. Press the **Unlock** softkey to unlock the front panel. If an Unlock Passcode has been set, a prompt to supply the passcode before the front panel will unlock is displayed.











## Alarms & remedies



The Medfusion® Model 3500 pump V6 has numerous alarms built into it. These are triggered by situations as a means of warning or advising that something is not functioning within normal parameters.

Pump alarms are logged into the pump's *Alarm History* (viewable in the **BIOMED** menu, and may be included in various reports via PharmGuard® Toolbox 2).

### Alarms / alerts types

Below is a table of the alarms and alerts generated by the pump, including definitions and remedies:

Type	Definition and Remedy
<p><b>System Fault priority</b></p>	<p>A <i>System Fault alarm</i> is initiated when one of the system fault conditions occur. Fluid delivery stops. System Fault alarms are signaled with a flashing red indicator, repeating audible signal and a viewing screen backlight that oscillates between bright and dim; the pump will return to the <b>MAIN</b> menu and show the <b>BIOMED</b> menu as the only choice.</p> <p>Press  to silence the audible alarm, then press  to turn the pump off. There is no other method for ending a <i>System Fault</i> alarm. If the alarm persists when the pump is turned back on, or if the <b>MAIN</b> menu shows only the <b>BIOMED</b> menu, the pump must be removed from service for inspection and repair by a trained biomedical technician.</p> <p>If the front panel controls are <i>locked</i> when a System Fault alarm occurs, the pump controls <i>do</i> unlock.</p> <p><b>Note:</b> System faults may result in subsequent faults being logged in the pump's <i>Alarm History</i>, however only the initial fault is displayed on the pump (due to the fact that the only method for ending the alarm is to turn the pump off).</p>
<p><b>High priority</b></p>	<p>A <i>high-priority alarm</i> is initiated by any condition that halts an ongoing infusion. High-priority alarms are signaled with a flashing red indicator, a viewing screen backlight that oscillates between bright and dim, and a repeating audible signal. Press  to return the viewing screen backlight to bright and silence the audible alarm for the programmed alarm silence period. During a high-priority alarm condition, all keys except  are locked. <b>You must silence the alarm by pressing  before any other action can be taken.</b></p> <p>If the front panel controls are <i>locked</i> when a high-priority alarm occurs, the pump controls <i>do</i> unlock.</p> <p>A <i>high-priority alarm</i> that stops delivery during a loading dose or bolus will not return to the <b>BEGIN DELIVERY</b> screen until the alarm is silenced – this allows you to record the portion of the loading dose/bolus volume delivered prior to the alarm sounding.</p>
<p><b>Medium priority</b></p>	<p>A <i>medium-priority alarm</i> indicates any condition requiring intervention but does not halt infusion. Medium-priority alarms are signaled with a flashing yellow indicator, a viewing screen backlight that oscillates between bright and dim, and a repeating audible signal. Pressing  will return the viewing screen backlight to bright and silence the audible alarm for the programmed alarm silence period. During a medium-priority alarm condition, all keys except  are locked. <b>You must silence the alarm by pressing  before any other action can be taken.</b></p> <p>If the front panel controls are <i>locked</i> when a medium-priority alarm occurs, the pump controls <i>do not</i> unlock.</p>

Type	Definition and Remedy
<p><b>Low priority</b></p>	<p>A <i>low-priority alarm</i> indicates any condition not requiring immediate operator intervention.</p> <p><i>Low-priority alarms</i> are announced with a continuous yellow indicator, a viewing screen backlight that oscillates between bright and dim and a non-repeating audible signal. During a low-priority alarm condition, all keys except  are locked. <b>You must silence the alarm by pressing  before any other action can be taken.</b></p> <p>If the front panel controls are <b>locked</b> when a low-priority alarm occurs, the pump controls <b>do not</b> unlock.</p>
<p><b>Limit priority</b></p>	<p>A limit priority alarm provides user feedback related to interaction with the pump.</p> <p><b>Note:</b> The audio part of the limit priority alarm is tied to “Key Click loudness”, which is set in PharmGuard® Toolbox 2. If key click loudness is set to <i>Off</i>, there will be no audible tone accompanying limit priority alarms (visual advisory messages will still appear in the display). The volume will otherwise sound at the loudness level selected for key clicks - Level 2 (quietest), Level 3, Level 4, or Level 5 (loudest).</p> <p>A <i>limit-priority alarm</i> sounds a three tone, non-repeating audible signal and displays an advisory message on screen for 3 seconds.</p> <p>If the front panel controls are <b>locked</b> when a low-priority alarm occurs, the pump controls <b>do not</b> unlock.</p>

### Re-displaying an alarm message



Whenever an alarm is silenced, the alarm message remains on the screen for approximately 3 seconds. This message can be re-displayed for an additional 3 seconds by pressing .

## “User Callback” alarm

The “User Callback” alarm is a *Medium* priority alarm that serves as a reminder to **finish what you started**. Once you begin programming any infusion delivery, the pump expects you to continue until setup is complete.

If the pump is paused too long (30 seconds) after a profile is selected or on a data entry screen, the pump initiates this alarm.

There are several basic resolutions:

- Press ANY key to silence the alarm for another 30 seconds.
- Go to the **BEGIN INFUSION** screen. There the alarm silence interval is one to two minutes, depending on the configuration.
- Use the Standby option to prevent the User Callback alarm while paused at the **BEGIN INFUSION** screen.
- Press  to begin the infusion.
- Cancel the infusion and return to the **SELECT THE PROFILE** screen, where no alarms sound.
- Press & hold  and turn the pump off.

## Syringe Empty Alarm Process

Sensing for an empty syringe can be a multi-step process on the Medfusion® Model 3500 pump V6. The “Syringe Near Empty” alarm and “Syringe Volume Near Empty” alarms are both calculated by the pump, based on infusion volume and time, and are designed to indicate the syringe is nearing empty so there is time to prepare for another syringe, if needed. The “Syringe Empty” and “Syringe Empty - Stop” alarms are the final alarms in the process, stopping fluid delivery when the syringe is empty.

The “Syringe Near Empty” alarm time is calculated based on the flow rate and syringe volume to occur at the set amount of time before the “Syringe Volume Near Empty” alarm. The “Syringe Volume Near Empty” alarm occurs at a syringe position near the end of the syringe travel. Due to variation in syringe dimensions, the pump will continue to infuse for a variable amount of time until the syringe plunger reaches the end of the syringe and the “Syringe

Empty” alarm sounds, stopping the infusion.

The “Syringe Near Empty” alarm time may be set and is useful in allowing preparation time for the next syringe on continuous infusions. This alarm indicates the time remaining to the “Syringe Volume Near Empty” alarm.

The “Syringe Volume Near Empty” alarm provides indication that the syringe is nearly empty. The remaining time to the “Syringe Empty” alarm is variable depending on syringe dimensional variation.

## “Syringe Near Empty” alarm

The **SYRINGE NEAR EMPTY** alarm is a *Medium* or *Low* priority alarm that occurs indicating that the syringe will reach empty in the “Near Empty Time” interval. The “Near Empty Time” interval ranges from 1 - 240 minutes. This time interval may be set via the “Near Empty Time” PharmGuard® Toolbox 2 setting as well as the alarm priority, *Low* or *Medium*.

**Note:** If the “Near Empty Time” is greater than or equal to the infusion time, the **SYRINGE NEAR EMPTY** alarm will sound as soon as the infusion is started.

The pump sounds the respective priority alarm tone, displays the near empty alarm message on screen, **but does not stop delivery**. Pressing  when this alarm is active silences the alarm. The “Syringe Near Empty” alarm occurs only once if the infusion is allowed to continue until it stops due to an “Infusion Complete,” “Syringe Empty,” or some other alarm.

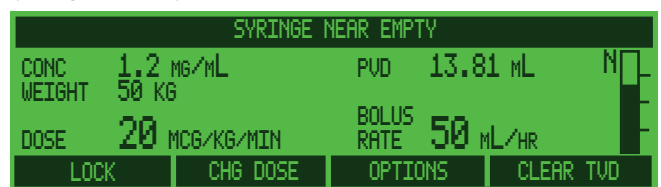



1. Press  to clear the alarm message.
2. Confirm how long before the infusion ends.
3. If necessary, prepare a new syringe to load onto the pump and then start a new infusion.

## “Syringe Volume Near Empty” alarm

The *Syringe Volume Near Empty* alarm is a *Low* priority alarm indicating that the syringe has reached the syringe position “Volume Empty”. Due to syringe variation there may still be a residual volume of



medication in the syringe; therefore the infusion continues.

1. Press .
2. If you **do not** wish to deliver any remaining fluid, or if the syringe is empty, press  and unload the syringe. Either prepare and load another syringe, return to the **SELECT THE PROFILE** screen (where no alarms sound), or turn the pump off.
3. The pump continues delivery, and continues until no fluid remains in the syringe.
4. When the syringe plunger reaches the end of the syringe, it halts delivery and displays the “**Syringe Empty**” message on screen.
5. Press . (The pump has stopped delivery and is at the **BEGIN INFUSION** screen.)
6. Either prepare and load another syringe, return to the **SELECT THE PROFILE** screen (where no alarms sound), or turn the pump off.

## “Syringe Empty” alarm

The **SYRINGE EMPTY** alarm is a *High* priority alarm advising the syringe is empty.

The Empty alarm stops delivery immediately.

1. Press  to clear the alarm tone & message.
2. Unload the syringe.
3. If the infusion is complete either turn the pump off or prepare for another infusion. If the infusion is not complete, prepare and load another syringe and:
  - return to the **SELECT THE PROFILE** screen (where no alarms sound) or turn off the pump. **OR**
  - if the mode in use was a continuous infusion, the screen displays **CONTINUE SAME INFUSION?**, with choices of **Yes** or **No**. Continue the infusion, or turn the pump off.

**Monoject® 1, 3, 12 and 35 mL:** Because of variations in syringe manufacturing, the Monoject® 1, 3, 12 and 35 mL syringes may in some cases not fully empty. Here, the empty alarm sounds with some fluid left in the syringe.

## System Advisory - Maintenance is Recommended

If your organization has set up a preventive maintenance policy for the Medfusion® Model 3500 pump V6 and programmed a preventive maintenance reminder in the **BIOMED** menu, a special alert is added. When it is time for a preventive maintenance inspection, each time the pump is turned on **SYSTEM ADVISORY : MAINTENANCE IS RECOMMENDED** appears at the top of the **MAIN** menu. Press  to silence the audible alarm and send pump for maintenance as soon as practical. This alert will recur each time the pump is powered up until a trained biomedical service technician has reset it.







## System Failures

System Failure alarms may indicate a problem with pump hardware or software. Occasionally, turning the pump off, then back on will clear the fault (see the pages that follow for specific information). If the alarm persists when the pump is turned back on, the pump must be removed from use and checked by a trained biomedical service technician. If the pump experiences *certain* system faults, a screen requiring entry of a Biomed Passcode will appear. If this screen appears, **immediately remove pump from service** for inspection/repair by a trained biomedical service technician.





## General system alarms & alerts









This section contains a table of the general system alarms, listed alphabetically, which may be encountered while operating the Medfusion® Model 3500 pump V6. This table identifies the alarm by message and type, and provides a definition and possible remedies.



**WARNING:** If a system failure alarm occurs and cannot be cleared by powering the pump down then back up, the pump cannot be used. Remove it from use and send it to a trained biomedical technician for service.



Alarm Message	Priority	Remedy
Calculated Rate Out of Range	High	Based on the values entered, the pump has calculated a rate that is not valid and cannot be delivered based on physical limits (such as syringe parameters). Press  . Verify that all infusion parameters have been entered correctly. If the invalid combination is part of a Drug Program, contact your PharmGuard® Toolbox 2 Administrator, who will have to review and correct the problem.
Check Clutch / Plunger Lever	High	The pump has sensed that the plunger driver is not moving correctly. This may be caused by a variety of issues such as the <b>Prime</b> function was not used before starting delivery (leaving slack in the drive system), the plunger levers are moved, the clutch is not properly engaged, the syringe in use is overfilled (causing the syringe plunger to reposition itself once the plunger driver begins moving forward), or there is a problem with the pump hardware. Press  and check the plunger lever and ensure the lever moves freely and is capturing the syringe plunger. Always use the <b>Prime</b> feature when loading a new syringe. If the alarm persists, remove the pump from service for repair by a trained biomedical service technician.
Check Syringe Barrel Clamp	Medium	Certain syringe models and sizes may cause the barrel clamp sensor to have difficulty in verifying the clamp is in position. When this alarm occurs press  , verify that the barrel clamp is indeed in place, then press <b>Confirm</b> . <b>OR</b>  When the pump was powered up, the syringe barrel clamp was lifted up and resting on the pump handle. When the syringe model is selected, this alarm occurs. Press  , press <b>Confirm</b> and continue loading the syringe. Ensure that the syringe barrel clamp is properly positioned on the syringe barrel.
Check Syringe Flange Sensor	High	Sensor is active when a syringe is not loaded correctly. Check the syringe flange holder. Ensure the syringe barrel clamp, flange holder, and plunger holders are properly engaged and the flange holder pulls back to the side of the case. If holder does not operate correctly or the alarm persists, immediately remove the pump from service for repair by a trained biomedical service technician.



Alarm Message	Priority	Remedy
Check Syringe Plunger Sensor	High	Sensor is active when syringe is not loaded correctly. Check the syringe plunger holders. Ensure the syringe barrel clamp, flange holder, and plunger holders are properly engaged and the holders move freely. If they do not operate correctly or if the alarm persists, immediately remove the pump from service for repair by a trained biomedical service technician.
Data Does Not Match Previous Entry	Limit	In cases where confirmation of entered data is required, the confirmation value did not match the originally programmed value. Re-enter the correct value.
Enter time as HH:MM (MM:SS) - Use 01:00 for 60 minutes (seconds)	Limit	The time value entered is greater than the maximum allowed for the minutes or seconds. Please try a lower value, and use 01:00 for a value greater than 59 minutes when programming hours, and 59 seconds when programming minutes.
Force Sensor Bgnd Test	High	A background self-test was performed on the force sensor while running an infusion, and the test failed due to a sensor malfunction. Press  . Press  to restart the infusion. If the alarm recurs, remove the pump from service for repair by a trained biomedical service technician.
Infusion Complete	High	The programmed infusion (based upon the values entered in the pump) has been delivered. Press  . Either begin a new infusion, return to the <b>SELECT THE PROFILE</b> screen (where no alarms sound), or turn off the pump.
Input Out of Range - Greater Than Max Value	Limit	The value entered is greater than the maximum allowed for the item. Please try a lower value.
Input Out of Range - Less Than Min Value	Limit	The value entered is less than the minimum allowed for the item. Please try a higher value.
Invalid Entry	Limit	There is a problem with the drug program selected, and the pump cannot deliver it. Contact your PharmGuard® Toolbox 2 Administrator, who will have to review and correct the problem.
Invalid Infusion Parameter Combination	Low	The combination of infusion parameters does not allow a valid flow rate to be calculated. Verify all infusion settings. If the invalid combination is part of a Drug Program, contact your PharmGuard® Toolbox 2 Administrator, who will have to review and correct the problem.
Invalid Syringe Size	High	Syringe size not recognized for the model selected, or the syringe barrel clamp was lifted during delivery. Review syringe sizes in the technical specifications section, and do not lift the syringe barrel clamp during delivery. If the alarm persists, remove the pump from service for repair by a trained biomedical technician.
KVO in Progress	Medium	Informational message that volume limit has been reached and KVO infusion is in progress. Press  .
Limits Adjusted - Cannot Deliver All Doses	Limit	The PharmGuard® Toolbox 2 specified soft limit values and syringe specified during programming would allow values to be entered that result in a rate outside the allowable limits. The pump has adjusted the limits to keep the rate inside allowable limits. Verify the values entered and the syringe size.

Alarm Message	Priority	Remedy
Motor Not Running	High	The motor is not running, which may be due to an erroneous (possibly transient) sensor signal, or a mechanical and/or electrical failure. Press  . Press  to turn the pump off, then back on. If the alarm persists when the pump is turned back on, <b>immediately remove the pump from service</b> for repair by a trained biomedical service technician.
Motor Rate Error	High	The motor is not running at the programmed rate, which may be due to an erroneous (possibly transient) sensor signal, or a mechanical and/or electrical failure. Press  . Press  to turn the pump off, then back on. If the alarm persists when the pump is turned back on, <b>immediately remove the pump from service</b> for repair by a trained biomedical service technician.
Occlusion - Check Infusion Line	High	Check infusion line for blockage. Clear or remedy any discovered occlusion; for example, check the infusion set for closed stopcocks, clamps, check the tubing for kinks, verify the patency of the tubing and the IV site, etc. Press  to restart infusion once occlusion is located and cleared. If this alarm occurs frequently and you have ruled out an actual blockage, the infusion set tubing may be too small for the rate or fluid viscosity, and you may want to consider enabling FlowSentry™ pressure monitoring, or you may want to consider choosing a different occlusion alarm setting in the Configuration. If you cannot clear the occlusion alarm, there may be a problem with the pump that requires repair by a trained biomedical technician.
Outside Range Limit - Silence Alarm to Continue	Medium	The entered rate is outside of the Drug Program soft limits. Press  to continue. You may then choose to override the range limit or change the value entered.
Periodic Callback - Silence Alarm to Continue	Medium	Press  . User programmed callback alarm - no remedy required.
PharmGuard Data Transfer is Recommended	Medium	As soon as possible, remove pump from service and transfer PharmGuard® Event Data to a host computer. Continued use may result in lost PharmGuard® Event Data.
Pressure Increasing - Check Infusion Line	Medium	Press  . FlowSentry™ pressure monitoring detects increasing pressure in the infusion line. Check infusion line for blockage; for example, check the infusion set for closed stopcocks, clamps, check the tubing for kinks, verify the patency of the tubing and the IV site, etc. Clear or remedy any discovered occlusion. If occlusion is not cleared, the “Occlusion” alarm will result.
Profile Does Not Match Last Settings Profile	Limit	The user attempted to use the “Recall Last Settings” feature. Recall Last Settings only works if the pump is in the same profile under which the previous infusion was programmed.
Pump is Locked	Limit	The keypad has been locked to prevent changes during infusion. The alarm is initiated by pressing any key except <b>Unlock</b> . Press <b>Unlock</b> to make changes to delivery settings.
Rate Below Recommended Min for Syringe Size	Limit	The programmed rate is below that recommended for the syringe size - no remedy required (see <i>Guidelines for enhanced pump performance</i> , page 22).



Alarm Message	Priority	Remedy
Restricted Flow - Bolus Cancelled	Medium	Bolus delivery was cancelled before completion. While the pump was delivering a bolus, the flow rate was restricted and initiated rate reduction, which eventually fell below the main infusion rate or extended past the maximum bolus time. Check the infusion line for occlusion.
Restricted Flow - Loading Cancelled	Medium	Loading dose delivery was cancelled before completion. While the pump was delivering a loading dose, the flow rate was restricted and initiated rate reduction, which eventually fell below the main infusion rate or extended past the maximum loading dose time. Check the infusion line for occlusion.
Restricted Flow - Rate Reduced	Medium	If the bolus or loading dose rate is high enough to trigger an occlusion alarm, the software reduces the rate until the bolus/loading dose is successfully delivered or, if the rate falls below a certain level or takes longer than the pump allows, is cancelled. With each rate reduction, this process repeats. Once silenced, the audible alarm tone will not reactivate, even if the process repeats.
Set Volume Limit Before KVO	Limit	Programming of a KVO rate was attempted, but there is no volume limit set. Program a volume limit, then set a KVO rate.
Syringe Does Not Match Entry	Limit	The drug program indicates a specific syringe, and the syringe in use is different. Verify the correct drug program and syringe are being used.
Syringe Empty	High	Press  . The syringe is now empty. Either: <ul style="list-style-type: none"> <li>• Prepare and load another syringe.</li> <li>• Return to the <b>SELECT THE PROFILE</b> screen, where no alarms sound.</li> <li>• Turn the pump off.</li> </ul>
Syringe Empty - Stop	High	Press  . The pump has either calculated (based on the syringe model in use) that the syringe should be at its forward-most travel point, or the pump's Syringe Plunger Driver has moved as far forward as is possible. Either: <ul style="list-style-type: none"> <li>• Prepare and load another syringe.</li> <li>• Return to the <b>SELECT THE PROFILE</b> screen, where no alarms sound.</li> <li>• Turn the pump off.</li> </ul>
Syringe Flange Not in Place	High	Press  . The syringe is not loaded correctly, or the sensor has failed. Make sure the syringe flange is properly inserted into the flange clip. Proceed with the infusion, if possible. If the alarm recurs, remove the pump from service for repair by a trained biomedical service technician.
Syringe Near Empty	Medium or Low*	The pump is indicating the syringe will soon be empty. The "Near Empty Time" interval ranges from 1 - 240 minutes. This time interval may be set via the "Near Empty Time" in PharmGuard® Toolbox 2, as well as the alarm priority, <i>Low</i> or <i>Medium</i> (the default priority is <i>Low</i> ). The alarm tone may be enabled/disabled in the <b>OPTIONS</b> menu if the Option is made available in the Profile; the default is enabled.

Alarm Message	Priority	Remedy
Syringe Plunger Not in Place	High	Press  . The syringe is not loaded correctly, or the sensor has failed. Make sure the syringe plunger head is properly inserted. Proceed with the infusion, if possible. If the alarm recurs, remove the pump from service for repair by a trained biomedical service technician.
Syringe Volume Near Empty	Low	Press  . The pump has calculated that the volume of medication in the syringe is nearly empty. The “Syringe Empty” Alarm will activate when the syringe is empty. Make preparations to install a new syringe, if necessary. The time until the syringe is empty can be estimated by estimating the volume remaining in the syringe and dividing by the delivery rate. The alarm tone may be enabled/disabled if the Option is made available in the Profile; default is tone disabled (silent).
User Call Back	Medium	The pump was left idle on a user input screen. Either: <ul style="list-style-type: none"> <li>• Finish the programming steps.</li> <li>• Return to the <b>SELECT THE PROFILE</b> screen, where no alarms sound.</li> <li>• Turn off the pump.</li> </ul>





\* “Syringe Near Empty” alarm priority is configurable separately for each profile using PharmGuard® Toolbox 2.

## System Failure and Advisory Alarms

### Battery Alarms

Alarm Message	Priority	Remedy
System Advisory : Battery Communication Timeout	Medium	The internal battery is not working. The pump may be used on AC power on a conditional basis. As soon as possible, remove pump from service for repair by a trained biomedical technician.
System Advisory: Battery Not Charging	Low	The internal battery is not charging. The pump may be used on AC power on a conditional basis. As soon as possible, remove pump from service for repair by a trained biomedical service technician.
System Advisory : Battery Not Working	Medium	The internal battery is not working. The pump may be used on AC power on a conditional basis. As soon as possible, remove pump from service for repair by a trained biomedical technician.
System Failure : Depleted Battery	System Fault	Press  to turn the pump off. The battery is completely drained. Plug in the AC power cord, then press  to turn the pump on. Until the battery is allowed to recharge, the pump can only be used if connected to AC power.
System Advisory : Low Battery	Medium or Low	<b>Initial:</b> Indicates battery is low, and needs charging soon or the pump will not be able to continue delivery. Press  . If possible, plug in power cord and run pump on AC mains while recharging the battery. As an additional reminder, for each 1% drop in capacity after the initial <i>Low Battery</i> alarm, the Low priority Low Battery alarm will sound.  If the pump is not plugged in, the amber alert LED will blink at the same rate as the battery indicator LED (as a visual reminder that the battery is low) until the <b>SYSTEM FAILURE - BATTERY DEPLETED</b> alarm occurs.

## System Failure Alarms

Alarm Message	Priority	Remedy
System Failure : Control Key Switch BGND Test	System Fault	Either a key on the keypad has been pressed for longer than 7 seconds, or the keypad needs to be replaced; fluid delivery stops. Press  to turn the pump off, then turn it back on. If the alarm persists when the pump is turned back on, <b>immediately remove pump from service</b> for repair by a trained biomedical technician.
System Failure: Configuration Required	System Fault	The pump has detected that a Configuration is not loaded onto the pump, and the pump cannot be used. A Configuration must be loaded onto the pump either using PharmGuard® Toolbox 2 or the Configuration Cloning procedure. Remove the pump from service and replace with another pump which has a validated Configuration.
System Failure: Force Sensor Test	System Fault	A self-test was performed on the force sensor, and the test failed due to a sensor malfunction <b>OR</b> the Syringe Plunger Driver was being moved during the pump startup process, or the Syringe Plunger Driver received a hard bump during the pump startup process. Press  . Press  to turn the pump off, then turn the pump back on. If alarm persists, remove the pump from service for repair by a trained biomedical service technician.
System Failure: Supercap Post	System Fault	Power-up self-test sensed insufficient charge in the super-capacitor. This problem can occur when a new Main PCB is installed or when a pump battery is totally dead. Plug the pump into AC power for at least two minutes then turn the pump off, then back on. If the alarm persists when the pump is turned back on, <b>immediately remove pump from service</b> for repair by a trained biomedical technician.
System Failure : xx xx xx	System Fault	Where “xx xx xx” indicates additional text for the specific type of failure. The pump display shows the <b>MAIN</b> menu, with only the <b>BIOMED</b> menu available. Some system failures result in a hardware “watchdog” alarm which results in an alarm tone sounding (and may or may not be accompanied by a flashing red alarm indicator). Press  to turn off pump, then back on. If the alarm persists when the pump is turned back on, <b>immediately remove pump from service</b> for repair by a trained biomedical technician.

## System Advisory Alarms

Alarm Message	Priority	Remedy
System Advisory : Improper Shutdown	Low	The pump improperly powered down. As soon as possible remove pump from service for repair by a trained biomedical technician.
System Advisory : Maintenance is Recommended	Low	The scheduled Preventive Maintenance is due. As soon as possible, remove pump from service for testing and checkout by a trained biomedical technician. This alarm will reactivate each time the pump is powered on until service is performed.
System Advisory : Set Time and Date	Low	The pump’s Time and Date settings have been lost. As soon as possible, remove pump from service for testing and checkout by a trained biomedical technician.

Alarm Message	Priority	Remedy
System Advisory : xx Data Corrupted	Low	Infusion will continue using backup copy of <i>xx data</i> (where <i>xx</i> represents variable text indicating the specific data that is corrupted). As soon as possible, remove pump from service for testing and checkout by a trained biomedical service technician.



## Battery and AC power operation

The infusion pump is typically operated by AC (mains) power.

The pump contains a rechargeable battery that is continually charged – as long as the pump is connected to AC power (see page 122 for battery life specification).

If the AC is disconnected while the pump is turned on, the pump automatically begins drawing power from the internal battery.

### *Attaching the power cord:*

1. Connect the AC power cord to the connector port on the pump.
2. Drop cord clip over the top of the connector (to prevent accidentally unplugging pump).

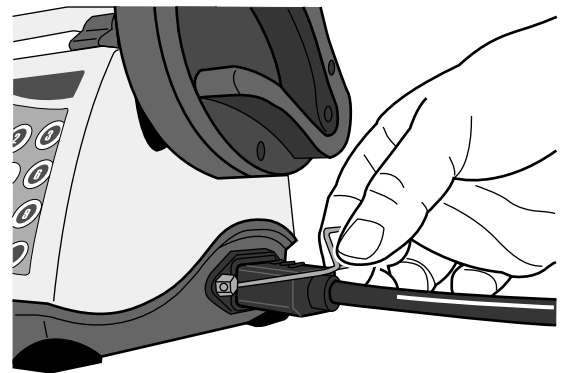
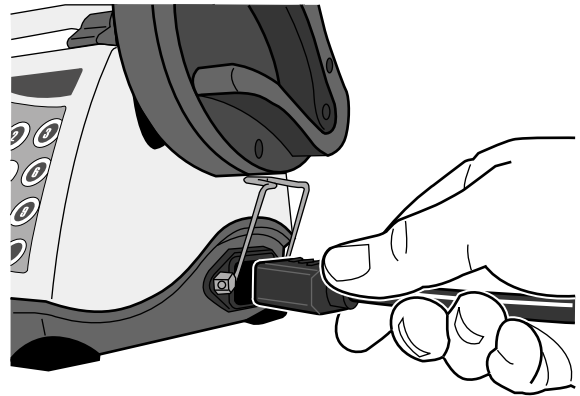

---

**WARNING: Shock Hazard.** The only means of removing AC power is to disconnect the AC power cord. While the AC power cord is attached to the pump and plugged into an AC outlet, live mains voltage is present inside the pump.

---

## On screen display of internal battery power level gauge

Whenever the pump is turned on, the internal battery charge level briefly appears on the “battery shaped” gauge in the bottom left corner of the display.

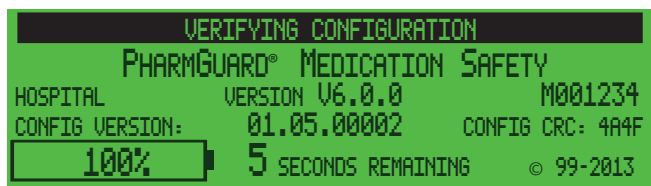

When running an infusion on internal battery, this “battery shaped” gauge also appears briefly in the upper right corner of the display at the start of delivery.

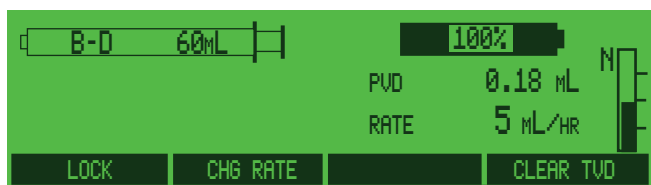

Briefly display this “battery shaped” gauge at any time while the pump is infusing on battery by pressing

**BACK**.

## Battery guidelines

Power & Battery Limits	
When to charge the battery	When the “BATTERY LOW” message displays, plug the pump into a power outlet for recharging. The battery indicator remains on continuously when charging. If the pump IS plugged into an outlet and fails to charge the battery, or the pump has been stored for longer than two months without charging, contact Service & Repair for information on how to test and/or service the battery.
When you <i>can</i> run on battery	The internal battery is intended to allow infusions of medications and fluids when an external power outlet is not conveniently available or when the patient is being moved.
When you <i>cannot</i> run on battery	When the battery becomes fully depleted, all infusion stops, and a “BATTERY DEPLETED” alarm begins sounding. For a fully depleted battery, plug in the AC power cord, turn the pump off to clear the alarm, and then turn the pump back on. Leave the pump plugged in for at least 16 hours to completely recharge the battery.

- See “General System Alarms and Alerts” table to identify battery message status.



## Poleclamp use

This section contains the instructions for using the poleclamp options available for the pump.

The poleclamp anchor is attached to the pump according to the *Instructions for Use* supplied with the poleclamp assembly.

**CAUTION:** This pump is designed to be used in a *horizontal* position. If the pump is operated in any other position (including vertical), there is an increased potential for fluid leaking into the pump. If you suspect fluid has leaked into a pump, remove it from service until a trained biomedical technician can test it.

**CAUTION:** Always verify the stability of the object to which the pump is mounted (for instance, an IV pole) before using the poleclamp. Failure to verify the stability could cause the object to tip, with the possibility of causing damage to the pump and other equipment. If the poleclamp is not adequately tightened, it could cause the pump to fall.

### Rotating/detachable poleclamp (standard)

Smiths Medical offers two rotating poleclamps, one with a 90-degree angle anchor bracket (catalog number 22-1050-51), and one with a 100-degree angle anchor bracket (catalog number 22-1051-51) (older pumps may use poleclamp catalog number 3000RPC, which is no longer available).

The 100-degree anchor bracket attaches the pump to a pole at a slight forward angle, making the display and keypad easier to view when pumps are attached to a pole in certain circumstances (for instance, high on a pole).

Align the poleclamp for mounting on any *vertical* or *horizontal* pole, bed rail, or similar solid structure small enough to fit within the clamp's jaws. The light weight of the pump makes this convenient.

1. Open the clamp jaws wide enough to easily slip around the pole.
2. Tighten the clamp ***until it is securely fastened*** so the pump cannot be moved.

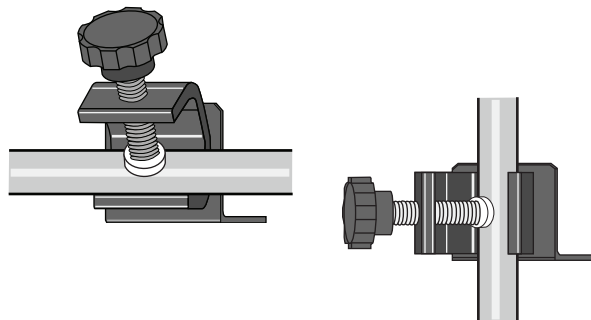
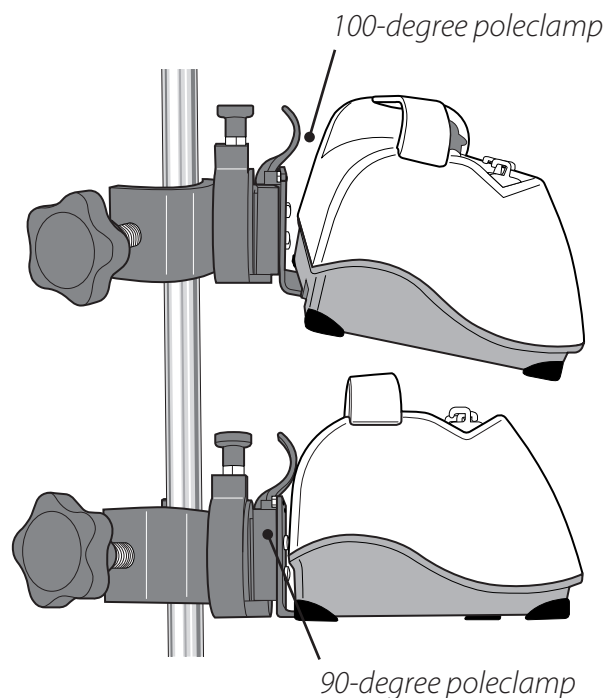

## Assembling the rotating/detachable poleclamp

1. If necessary, slide the rotating poleclamp onto the poleclamp anchor at the rear of the pump until the retainer lock button audibly clicks into place.
2. Pull the round lock button at the top of the clamp assembly up and rotate the clamp to the desired angle. The poleclamp can be rotated so the pump is horizontal, vertical, or at a 45° angle to either side of vertical.
3. To remove the poleclamp from the pump, pull the release lever toward the pump and slide the poleclamp off the pump.

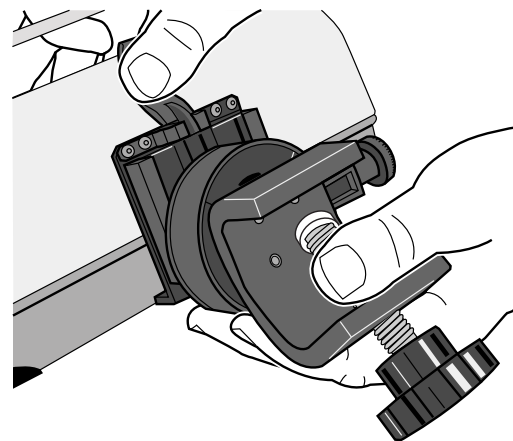
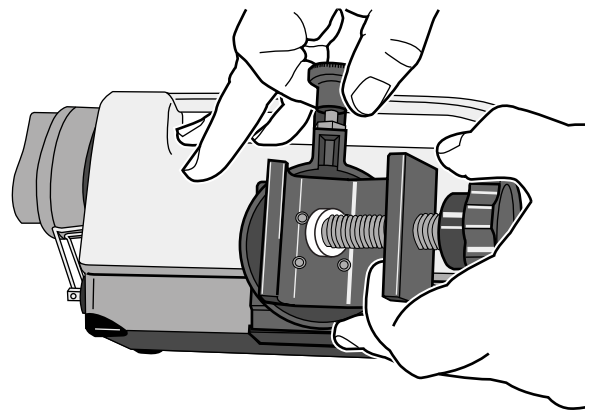
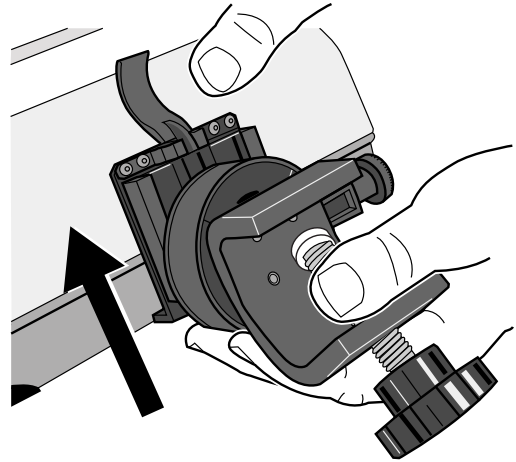

## EMC information for the Medfusion® Model 3500 pump V6

Electromagnetic Compliance (EMC) precautions are necessary when dealing with the Medfusion® Model 3500 pump V6. Accessible pins of connectors identified with the ESD warning symbol near them should not be touched with the fingers or hand-held tool, unless proper precautionary measures are followed. These measures include:

- 1) Discharging one's body to earth or to a large metal object.
- 2) Bonding oneself by means of an ESD wrist strap to earth.

It is recommended that all staff, including clinical and biomedical staff, receive training in the meaning of the ESD warning symbol, and on the above precautionary measures.

This training should also include an introduction to the physics of electrostatic discharge, the voltage levels that can occur in normal practice, and the damage that can be done to electronic components if they are touched by an operator who is electrostatically charged. Further, an explanation should be given of the methods to prevent build-up of electrostatic charge, and how and why to discharge one's body to earth, or to bond oneself by means of a wrist strap to earth prior to making a connection.

### Use of cables

---

#### WARNINGS:

- Use of cables other than as listed below may result in increased EMC emissions or decreased immunity of the pump.
  - Use of the listed cables with equipment other than those specified may result in increased EMC emissions or decreased immunity of the equipment or system.
  - The pump should not be used adjacent to or stacked with other equipment. If adjacent or stacked use is necessary, the user should verify normal operation of the pump in the configuration in which it is to be used.
- 

This pump has been tested for EMC with the following cable:

- Smiths Medical G6000329 AC power cord (USA)

### Stacked equipment

---

**WARNING:** The pump should not be used adjacent to or stacked with other equipment. If adjacent or stacked use is necessary, the user should verify normal operation of the pump in the configuration in which it is to be used.

---

Medical Electrical Equipment needs special precautions regarding EMC and needs to be installed and put into service according to the EMC information provided in this manual.

Portable and mobile RF communication equipment can affect Medical Electrical Equipment.

# Technical specifications & other information

## Pump development standards

### Medical Electrical Equipment Safety

Reference (Year)	Title
IEC 60601-1 (1988)	Medical Electrical Equipment, Part 1: General Requirements for Safety, Amendment 1 (1991), Amendment 2 (1995)
IEC 60601-1-4 (2000)	Medical electrical equipment -- Part 1-4: General requirements for safety - Collateral standard: Programmable electrical medical systems
IEC 60601-1-6 (2006)	Medical electrical equipment – Part 1-6: General requirements for safety – collateral standard: usability
IEC 60601-2-24 (1998)	Medical Electrical Equipment, Part 2: Particular requirements for safety of infusion pumps and controllers
IEC 62304 (2006)	Medical device software - Software life cycle processes
IEC 62366 (2007)	Medical Devices, Application of usability engineering to medical devices
EN 475 (1995)	Medical Devices - Electrically -generated alarm signals
UL 60601-1 (2006)	Medical Electrical Equipment, Part 1: General Requirements for Safety (US Deviations to IEC 60601-1)
CAN/CSA-C22.2 No. 601.1-M90 (1990)	Medical Electrical Equipment, Part 1: General Requirements for Safety – November 1990 (Canadian Deviations to IEC 60601-1) Update No. 2 (November 2003)
AS/NZS 3200.1.0 (1998)	Australian/New Zealand Standard, Medical electrical equipment - Part 1.0: General requirements for safety - Parent Standard (Australian Deviations to IEC 60601-1)
AS/NZS 3200.2.24 (1999)	Medical Electrical Equipment: Part 2-24: Particular requirements for safety- Infusion pumps and controllers

### Electromagnetic Compatibility

Reference (Year)	Title
IEC 60601-1-2 (2007)	Medical electrical equipment - Part 1.2: General requirements for safety - Collateral standard: Electromagnetic compatibility - Requirements and tests. Amendment 1 (2004)  (Applies to all sections except IEC/EN 61000-4-2, Electrostatic Discharge Immunity test)
IEC 60601-1-2 (1993)	Medical electrical equipment - Part 1.2: General requirements for safety - Collateral standard: Electromagnetic compatibility - Requirements and tests  (Applies to section IEC/EN 61000-4-2, Electrostatic Discharge Immunity test)
EN 60601-1-2 (2007)	Medical electrical equipment - Part 1.2: General requirements for safety - Collateral standard: Electromagnetic compatibility - Requirements and tests.  (Applies to all sections except IEC/EN 61000-4-2, Electrostatic Discharge Immunity test)
EN 60601-1-2 (1993)	Medical electrical equipment - Part 1.2: General requirements for safety - Collateral standard: Electromagnetic compatibility - Requirements and tests  (Applies to section IEC/EN 61000-4-2, Electrostatic Discharge Immunity test)

Reference (Year)	Title
IEC/EN 61000-4-2	Electromagnetic Compatibility (EMC), Part 4: Testing and measurement techniques. Section 2: Electrostatic Discharge immunity test. Basic EMC Publication
IEC/EN 61000-4-3	Electromagnetic Compatibility (EMC), Part 4: Testing and measurement techniques. Section 3: Radiated, radio frequency, electromagnetic fields immunity test. Basic EMC Publication
IEC/EN 61000-4-4	Electromagnetic Compatibility (EMC), Part 4: Testing and measurement techniques. Section 4: Electrical fast transients/bursts immunity test. Basic EMC Publication
IEC/EN 61000-4-5	Electromagnetic Compatibility (EMC), Part 4: Testing and measurement techniques. Section 5: Surge immunity test. Basic EMC Publication
IEC/EN 61000-4-6	Electromagnetic Compatibility (EMC), Part 4: Testing and measurement techniques. Section 6: Immunity to conducted disturbances, induced by radio frequency fields. Basic EMC Publication
IEC/EN 61000-4-8	Electromagnetic Compatibility (EMC), Part 4: Testing and measurement techniques, Section 8: Power frequency magnetic field immunity test. Amendment.
IEC/EN 61000-4-11	Electromagnetic compatibility (EMC) - Part 4: Testing and measuring techniques - Section 11: Voltage dips, short interruptions and voltage variations immunity tests
EN 55011 (2009)	Industrial, scientific and medical (ISM) radio frequency equipment - Radio disturbance characteristics - Limits and methods of measurement. Amendment 1 (2010)
AS/NZS 3200.1.2 (2005)	Australian/New Zealand Standard, Medical electrical equipment - Part 1.2: General requirements for safety - Collateral standard: Electromagnetic compatibility - Requirements and tests Parent Standard  (Applies to all sections except IEC/EN 61000-4-2, Electrostatic Discharge Immunity test)
AS/NZS 3200.1.2 (1995)	Australian/New Zealand Standard, Medical electrical equipment - Part 1.2: General requirements for safety - Collateral standard: Electromagnetic compatibility - Requirements and tests Parent Standard  (Applies to section IEC/EN 61000-4-2, Electrostatic Discharge Immunity test)
CISPR 11 (2003)	Industrial, scientific and medical (ISM) radio frequency equipment electromagnetic disturbance characteristics - limits and methods of measurement. Amendment 1 (2004), Amendment 2 (2006).
ASTM F2052-02	Standard Test Method for Measurement of Magnetically Induced Displacement Force on Medical Devices in the Magnetic Resonance Environment

### Miscellaneous Standards

Reference (Year)	Title
IEC 60320-1 (2001)	Appliance couplers for household and similar general purposes - Part 1: General requirements  (IEC 60320-1:2001 + Amendment 1:2007)
IEC 60529 (2001)	Degrees of Protection Provided by Enclosures (IP Code)
IEC 60878 (2003)	Graphical Symbols for electrical equipment in medical practice
EN 980 (2008)	Graphical Symbols for Use in the Labeling of Medical Devices

<b>Reference (Year)</b>	<b>Title</b>
EN 1041 (2008)	Information Supplied by the Manufacturer with Medical Devices
EN ISO 10993-1 (2003)	Biological Evaluation of Medical Devices Part 1: Evaluation and Testing
ASTM F2503-08	Standard Practice for Marking Medical devices and Other Items for Safety in the Magnetic Resonance Environment
ISO 3744 (1994)	Acoustics- Determination of Sound Power Levels
EN ISO 14971 (2007)	Medical Devices, Application of Risk Management to Medical Devices
UL746C (2004)	Polymeric Materials - Use in Electrical Equipment Evaluations

**Guidance and Manufacturer's Declaration – Electromagnetic Emissions**

The Medfusion® Syringe Pump Model 3500 V6 is intended for use in the electromagnetic environment specified below. The customer or the user of the Medfusion® Syringe Pump Model 3500 V6 should assure that it is used in such an environment.

Emissions test	Compliance	Electromagnetic environment - guidance
RF Emissions  CISPR 11	Group 1	The Medfusion® Syringe Pump Model 3500 V6 uses RF energy only for its internal function. Therefore, its RF emissions are very low and are not likely to cause any interference in nearby electronic equipment RF emissions.
RF emissions CISPR 11	Class A	The Medfusion® Syringe Pump Model 3500 V6 is suitable for use in all establishments other than domestic and those directly connected to the public low-voltage power supply network that supplies buildings used for domestic purposes.
Harmonic emissions  IEC 61000-3-2	Not Applicable	
Voltage fluctuations/ Flicker emissions  IEC 61000-3-3	Not Applicable	

**Compliance using:**

1. AC power cord length of 2.4 m (8 feet).
2. Rechargeable NiMH battery pack.

---

**WARNING:** The pump should not be used adjacent to or stacked with other equipment. If adjacent or stacked use is necessary, the user should verify normal operation of the pump in the configuration in which it is to be used.

---



## Guidance and Manufacturer's Declaration – Electromagnetic Immunity

The Medfusion® Syringe Pump Model 3500 V6 is intended for use in the electromagnetic environment specified below. The customer or the user of the Medfusion® Syringe Pump Model 3500 V6 should assure that it is used in such an environment.

Immunity test	IEC 60601 Test level	Compliance level	Electromagnetic environment-guidance
Electrostatic Discharge (ESD) IEC 61000-4-2	±6 kV contact ±8 kV air	±8 kV contact ±15 kV air	Floors should be wood, concrete or ceramic tile. If floors are covered with synthetic material, the relative humidity should be at least 30%.
Electrical fast Transient/burst IEC 61000-4-4	±2 kV for power supply lines ±1 kV for input/output lines	±2 kV for power supply lines ±1 kV for input/output lines	Mains power quality should be that of a typical commercial or hospital environment.
Surge IEC 61000-4-5	±1 kV differential mode ±2 kV common mode	±1 kV differential mode ±2 kV common mode	Mains power quality should be that of a typical commercial or hospital environment.
Voltage dips, short interruptions and voltage variations on power supply input lines IEC 61000-4-11	<5 % U <sub>T</sub> (>95 % dip in U <sub>T</sub> ) for 0.5 cycle  40 % U <sub>T</sub> (60 % dip in U <sub>T</sub> ) for 5 cycles  70 % U <sub>T</sub> (30 % dip in U <sub>T</sub> ) for 25 cycles  <5 % U <sub>T</sub> (>95 % dip in U <sub>T</sub> ) for 5 sec	<5 % U <sub>T</sub> (>95 % dip in U <sub>T</sub> ) for 0.5 cycle  40 % U <sub>T</sub> (60 % dip in U <sub>T</sub> ) for 5 cycles  70 % U <sub>T</sub> (30 % dip in U <sub>T</sub> ) for 25 cycles  <5 % U <sub>T</sub> (>95 % dip in U <sub>T</sub> ) for 5 sec	Mains power quality should be that of a typical commercial or hospital environment. If the user of the Medfusion® Syringe Pump Model 3500 V6 requires continued operation during power mains interruptions, it is recommended that the Medfusion® Syringe Pump Model 3500 V6 be powered from an uninterruptible power supply or a battery.
Power frequency (50/60 Hz) Magnetic field IEC 61000-4-8	3 A/m	400 A/m and 3 A/m	Power frequency magnetic fields should be at levels characteristic of a typical location in a typical commercial or hospital environment.

Note: U<sub>T</sub> is the AC mains voltage prior to application of the test level.



## Guidance and manufacturer's declaration – electromagnetic immunity

The Medfusion® Syringe Pump Model 3500 V6 is intended for use in the electromagnetic environment specified below. The customer or the user of the Medfusion® Syringe Pump Model 3500 V6 should assure that it is used in such an environment.

Immunity test	IEC 60601 test level	Compliance level	Electromagnetic environment - guidance
Conducted RF IEC 61000-4-6	3 Vrms 150 kHz to 80 MHz outside ISM bands <sup>a</sup>	3 V	Portable and mobile RF communications equipment should be used no closer to any part of the Medfusion® Syringe Pump Model 3500 V6, including cables, than the recommended separation distance calculated from the equation applicable to the frequency of the transmitter.  <b>Recommended separation distance</b> $d = 1.2 \sqrt{P}$
	10 Vrms 150 kHz to 80 MHz in ISM bands <sup>a</sup>	10 V	
Radiated RF IEC 61000-4-3	10 V/m 80 MHz to 2.5 GHz	10 V/m	$d = 1.2 \sqrt{P}$ 80 MHz to 800 MHz  $d = 2.3 \sqrt{P}$ 800 MHz to 2.5 GHz  where P is the maximum output power rating of the transmitter in watts (W) according to the transmitter manufacturer and d is the recommended separation distance in metres (m). <sup>b</sup>  Field strengths from fixed RF transmitters, as determined by an electromagnetic site survey, <sup>c</sup> should be less than the compliance level in each frequency range. <sup>d</sup>  Interference may occur in the vicinity of equipment marked with the following symbol:  

NOTE 1 At 80 MHz and 800 MHz, the higher frequency range applies.

NOTE 2 These guidelines may not apply in all situations. Electromagnetic propagation is affected by absorption and reflection from structures, objects and people.

<sup>a</sup> The ISM (industrial, scientific and medical) bands between 150 kHz and 80 MHz are 6.765 MHz to 6.795 MHz; 13.553 MHz to 13.567 MHz; 26.957 MHz to 27.283 MHz; and 40.66 to 40.70 MHz.

<sup>b</sup> The compliance levels in the ISM frequency bands between 150 kHz and 80 MHz and in the frequency range 80 MHz to 2.5 GHz are intended to decrease the likelihood that mobile/portable communications equipment could cause interference if it is inadvertently brought into patient areas. For this reason, an additional factor of 10/3 is used in calculating the recommended separation distance for transmitters in these frequency ranges.

<sup>c</sup> Field strengths from fixed transmitters, such as base stations for radio (cellular/cordless) telephones and land mobile radios, amateur radio, AM and FM radio broadcast and TV broadcast cannot be predicted theoretically with accuracy. To assess the electromagnetic environment due to fixed RF transmitters, an electromagnetic site survey should be considered. If the measured field strength in the location in which the Medfusion® Syringe Pump Model 3500 V6 is used exceeds the applicable RF compliance level above, the Medfusion® Syringe Infusion Pump Model 3500 should be observed to verify normal operation. If abnormal performance is observed, additional measures may be necessary, such as reorienting or relocating the Medfusion® Syringe Pump Model 3500 V6.

<sup>d</sup> Over the frequency range 150 kHz to 80 MHz, field strengths should be less than 3 V/m.

**Recommended separation distances between portable and mobile RF communications equipment and the Medfusion® Syringe Infusion Pump Model 3500 V6**

The Medfusion® Syringe Pump Model 3500 V6 is intended for use in an electromagnetic environment in which radiated RF disturbances are controlled. The customer or the user of the Medfusion® Syringe Pump Model 3500 V6 can help prevent electromagnetic interference by maintaining a minimum distance between portable and mobile RF communications equipment (transmitters) and the Medfusion® Model 3500 pump V6 as recommended below, according to the maximum output power of the communications equipment.

Rated Maximum output power or transmitter W	Separation distance according to frequency of transmitter (m)			
	150 kHz to 80 MHz outside ISM bands $d = 1.17\sqrt{P}$	150 kHz to 80 MHz in ISM bands $d = 1.2\sqrt{P}$	80 MHz to 800 MHz $d = 1.2\sqrt{P}$	800 MHz to 2.5 GHz $d = 2.3\sqrt{P}$
0.01	.12	.035	.035	.23
0.1	.37	.38	.38	.73
1	1.2	1.2	1.2	2.3
10	3.7	3.8	3.8	7.3
100	12	12	12	23

For transmitters rated at a maximum output power not listed above, the recommended separation distance d in meters (m) can be determined using the equation applicable to the frequency of the transmitter, where P is the maximum output power rating of the transmitter in watts (W) according to the transmitter manufacturer.

NOTE 1 At 80 MHz and 800 MHz, the separation distance for the higher frequency range applies.

NOTE 2 The ISM (industrial, scientific and medical) bands between 150 kHz and 80 MHz are 6.765 MHz to 6.795 MHz; 13.553 MHz to 13.567 MHz; 26.957 MHz to 27.283 MHz; and 40.66 MHz to 40.70 MHz.

NOTE 3 An additional factor of 10/3 is used in calculating the recommended separation distance for transmitters in the ISM frequency bands between 150 kHz and 80 MHz and in the frequency range 80 MHz to 2.5 GHz to decrease the likelihood that mobile/portable communications equipment could cause interference if it is inadvertently brought into patient areas.

NOTE 4 These guidelines may not apply in all situations. Electromagnetic propagation is affected by absorption and reflection from structures, objects and people.

## Technical specifications

### Specifications

Below are the technical specifications of the Medfusion® Model 3500 pump V6. Testing was performed using the syringes listed in the table on page 128 and the following Medfusion® Administration Sets: 1) Model 536040 for low flow rates and 2) Model MX448HL60 for high flow rates.

<b>Minimum increment of resolution</b>	0.01 mL/hr			
<b>Size (pump only)</b>	27cm wide × 13cm high × 14cm deep (10.5" × 5.1" × 5.5")			
<b>Weight</b>	Approximately 1.7 kg (3.8 lbs.)			
<b>Classification</b>	Type CF (protection from electric shock)			
<b>Moisture protection</b>	IPX3 (sprayproof)			
<b>Pump Alarms</b>	<p>Syringe empty, syringe near empty, syringe not loaded properly, incorrect syringe size, infusion complete, KVO, battery low/damaged/not working, incorrect calculation, (value) out of range, occlusion/fluid restricted/rate reduced/pressure increasing, pump stopped, system fault, system advisory (set time/date, maintenance recommended, data corrupted)</p> <p>For a complete list of alarms, see the General system alarms and alerts table starting on page 103.</p>			
<b>Time to occlusion alarm</b>	Very High (50 psi) testing performed using B-D® 1 mL syringe; High and Very Low testing performed using B-D® 20 mL syringe (syringes meet the requirements of the ISO 7886-2 standard).			
	<i>Flow Rate (mL/hr)</i>	<i>Syringe (Mfg / Size)</i>	<i>Occlusion Setting</i>	
			<i>Max time to occlusion (Start-up) hr:min:sec</i>	
	1 (minimum)	B-D® 1 mL	Very High (50 psi)	00:10:00
		B-D® 20 mL	High (16 psi)	00:31:00
				Very Low (4 psi)
5 (intermediate)	B-D® 1 mL	Very High (50 psi)	00:01:00	
	B-D® 20 mL	High (16 psi)	00:06:00	
			Very Low (4 psi)	00:05:00
<b>Power source</b>	<i>Internal battery:</i>	Rechargeable (nickel metal hydride)		
	<i>AC power:</i>	100-240 VAC, 50/60 Hz, 30VA; Safety Class II		
	<i>DC Power Supply (optional)</i>	External DC Input 6 – 14 VDC, 7 Watts Safety Class II – Type CF (must meet IEC 60601-1 Medical Equipment Standards)		
<b>Battery Life</b>	500 full discharge/charge cycles or 2 years, whichever comes first			
<b>Battery longevity</b>	At 25° C (77°F), a fully charged battery will run the pump for at least 6 hours when running a continuous rate of 5 mL/hr and using a 60mL syringe.			

<b>Operating conditions</b>	<i>Temperature:</i>	5° to 40° C (41° to 104° F)		
	<i>Relative Humidity:</i>	20% to 95% non-condensing		
	<i>Ambient Pressure:</i>	70 kPa to 106 kPa (10.2 psia to 15.4 psia)		
<b>Storage/transportation conditions</b>	<i>Temperature:</i>	-20° to 50°C (-4° to 122°F)		
	<i>Relative Humidity:</i>	20% to 95% non-condensing		
	<i>Ambient Pressure:</i>	70 kPa to 106 kPa (10.2 psia to 15.4 psia)		
	<b>NOTE:</b> The pump may not meet performance specifications when stored, transported or used outside the ranges given above for storage/transport and operating conditions.			
<b>Infusion Back Pressure</b>	-100 mmHg to 300 mmHg			
<b>Delivery Accuracy</b>	Nominal ± 2% (± syringe accuracy) (for infusion back pressures of -100 mmHg to +300 mmHg). At low infusion rates, the system accuracy may not be achieved for short periods. During the total infusion time, the accuracy averages out (see accuracy curves, page 136). Overall flow rate accuracy is equal to pump accuracy combined with syringe tolerances. For syringes specified to meet the ISO 7886-2 standard, syringe accuracy may be expected to meet the ± 2% requirement.			
	<b>WARNING:</b> Ensure that the ± 2% accuracy specification is taken into account when programming the pump and/or filling a syringe. If accuracy is of prime concern, use only syringes that meet the ± 2% requirement of the ISO 7886-2 Standard. Failure to do so may result in medication in the syringe becoming depleted sooner than expected. If the pump is being used to deliver critical or life sustaining medication, the interruption in the delivery of medication could result in patient injury or death.			
<b>Bolus Accuracy</b>	This data gathered using a BD® 20 mL syringe			
		<i>Minimum Bolus*</i>	<i>Minimum Recommended Bolus</i>	<i>Maximum Bolus</i>
	Average (mL)	0.030	0.988	19.830
	% Average Error	-11.09	-1.23	-0.85
	Maximum Pos. Error %	14.12	0.32	-0.38
	Maximum Neg. Error %	-44.71	-3.52**	-1.369
	Minimum Deviation (mL)	-0.004	0.003	-0.075
	Maximum Deviation (mL)	-0.015	-0.035	-0.272
	* <b>IMPORTANT:</b> “Minimum Bolus” refers to the minimum bolus that <i>can</i> be set on the pump, and which may be below the <i>recommended</i> minimum rate for the syringe. ** <b>NOTE:</b> 2% of the measured error may be due to syringe characteristics per ISO 7886-2.			

<p><b>Occlusion Alarm</b></p>	<p>For 1 mL Syringes, the occlusion limit is fixed at <i>Very High</i>.  <i>Very High</i> (1 mL syringe only, not selectable): 50 psi (2585 mmHg) (345 kPa)</p> <p>For Syringes with a volume greater than 1 mL, the user can set the occlusion limit from Very Low to High.  <i>High</i>: 16 psi (827 mmHg) (110 kPa)  <i>Normal</i>: 12 psi (621 mmHg) (83 kPa)  <i>Low</i>: 8 psi (413 mmHg) (55 kPa)  <i>Very Low</i>: 4 psi (206 mmHg) (28 kPa)</p>	
<p><b>Maximum volume infused under single fault conditions</b></p>	<p>1/100<sup>th</sup> of the syringe size by volume</p>	
<p><b>Maximum delivery rate during bolus</b></p>	<p>The configured maximum rate at which a bolus or loading dose can be delivered is: Syringe size ×5mL/hr, Syringe size ×10mL/hr or Syringe size Max mL/hr (see page 133 for further explanation)</p>	
<p><b>Maximum delivery rate during Prime</b></p>	<p>The priming delivery rate is 300 mL/hr or the default maximum bolus rate for the syringe size being used (Syringe size ×5mL/hr, Syringe size ×10mL/hr or Syringe size Max mL/hr), whichever is lower (see page 133, Maximum Bolus Rate, for further explanation)</p>	
<p><b>Infusion rate range:</b></p>	<p>0.01 mL/hr to 1130 mL/hr in increments of 0.01/0.1 mL/hr (depending on syringe size/rate). Refer to syringe tables on page 129 for Minimum Recommended Rate.</p>	
<p><b>Bolus volume range:</b></p>	<p>Volume is limited to the maximum fill volume of the current syringe size, and minimum volume is 1/600<sup>th</sup> the syringe size</p>	
	<p><b>Note:</b> The Minimum Recommended Bolus Volume is 10% of syringe or 1 mL, whichever is smaller. Bolus volumes delivered that are less than the recommended minimum bolus volume for the syringe used may result in delivery inaccuracies.</p>	
<p><b>Delivery modes (user customized)</b></p>	<p><u>Continuous Delivery Modes:</u>  Dose / min, hr, day  Dose / kg / min, hour, day  Dose / m2 / min, hr, day  mL / hr  mL / kg / min, hr</p>	<p><u>Intermittent Delivery Modes:</u>  Dose / kg / time  Dose / m2 / time  mL / kg / time  Volume / time  Dose / time  Intermittent volume / time</p>
<p><b>Delivery Options (user customized)</b></p>	<p>Volume Limit  Bolus Dose  Loading Dose  KVO  Standby  Override Occlusion Limit  Periodic Callback</p>	<p>Toggle FlowSentry™  Delayed Start  Override Alarm Loudness  Toggle PVD/PDD  Disable/Enable Vol Empty Tone  Disable/Enable Near Empty Tone</p>

<p><b>User-defined libraries</b></p>	<p>Standard libraries are organized on a per Profile basis. Each Profile allows up to eight library Categories with up to 36 Drug Programs each, for a possible total of 288 entries per profile</p> <p>One “Quick Library” per Profile for rapid setup</p>
<p><b>Accessories (may not be available in all areas; contact customer service for availability)</b></p>	<p>Rotating Poleclamp (catalog numbers: 100-degree - 22-1051-51; 90-degree - 22-1050-51)</p> <p>PharmGuard® Toolbox 2, Version 3 or higher</p> <p>Medfusion® Standard Configuration (catalog number 67-2460-[current version])</p> <p>Medfusion® Standard Syringes (catalog number 67-2459-[current version])</p> <p>Lockbox with Keys (22-1000-51)</p> <p>Infrared - RS232 Converter Box (3000RS232)</p> <p>Cloning Block (G6000200)</p> <p>PharmGuard® Supported Syringes (PSS) Series 2 (various, contact Smiths Medical for details)</p> <p>For replacement parts, including power cords and replacement battery packs, see the <i>Medfusion® Model 3000 Series Technical Service Manual</i> (catalog number G6000278)</p>



## Safety Features

### Safety Features and Fault Detection

#### Hardware Safety Features

A watchdog circuit, made up of a separate microcontroller with a dedicated timer, alarm speaker, and power supply, monitors the main microprocessor and associated electronics. The purpose of this circuit is to detect failures of the system including power, electronics and software, and generate an alarm if one is detected. If a failure is detected, a watchdog or "SYSTEM FAILURE" alarm will be generated through the dedicated speaker, the red alarm indicator will be turned on, and the pumping mechanism will be disabled. Some watchdog failures (for example, one that may occur rarely when powering down following a Configuration update) may be cleared by cycling power on the pump.

#### Software Safety Features

##### Hardware-related Software Safety Features

##### Program Memory - Check FLASH memory POST or BGND

At power up and at regular intervals thereafter, the program memory is tested by calculating a Cyclic Redundancy Code (CRC) on the program and then comparing it with the CRC stored with the program.

If the stored and calculated CRCs do not match, the software will display a system fault screen, turn on a continuous audible alarm, and stop all drug delivery.

##### RAM Memory Check - RAM BGND

During operation, the random access memory is checked. A series of bit patterns is written to and read from the RAM. If the read data is different from the written data, the software will display a system fault screen, turn on a continuous alarm, and stop all drug delivery.

##### Motor Circuit Check - pump motor phase A or B POST and Motor rate error during operation

At power up the pump performs power on self test (POST) checks of the motor. Motor POST checks include the ability to drive current to the motor

(Motor Drive Phase A/B POST, the ability for the watchdog to stop the motor (Motor Drive off POST).

Periodically during pump operations the software checks motor operation in background. Motor background checks include the stopping of the motor when an infusion stops and the motor supply voltage test.

If a motor POST or background check fails the pump will display a system fault screen, turn on a continuous two-tone audible alarm, flash the backlight and stop all drug delivery.

If the Motor shaft fails to complete the first shaft rotation (Motor Not Running) or a subsequent shaft rotation (Motor Rate Error) with the expected timing the pump will display a high priority alarm, turn on a continuous two-tone audible alarm, flash the backlight and stop all drug delivery.

When the pump is powered on with a depleted battery and no AC power, this alarm may sound due to the low battery state. Recharge the battery, turn the pump on, turn the pump off, then turn the pump on to clear the condition.

##### Keyboard Encoder Check - Control key POST or BGND

Every time the software receives data from the keyboard encoder, it is checked. If the data is not a valid key press, the software will disregard the key press.

### Data Handling Software Safety Features

#### Data Stored in EEPROM - Critical data POST or EEPROM timeout or Primary/Secondary critical data corrupted

Before use, data associated with delivery and stored in EEPROM is tested by calculating a CRC on the data and then comparing it with the CRC stored with the data. If the EEPROM timeout occurs or EEPROM Primary and Secondary stored and calculated CRCs do not match, the software will display a system fault screen, turn on a continuous two-tone audible alarm, and stop all drug delivery.

#### Data Used in Calculations - Critical data failure

Calculations on data used in some way to control the

delivery of drug are performed redundantly.

The two calculated values are then compared. If the two values do not match, the software will display a system fault screen, turn on a continuous two-tone audible alarm, and stop all drug delivery.

**Timer Data Registers - Time base BGND, time of day clock POST, time of day clock timeout**

The data in the Real Time Clock is checked at regular intervals. If the data is not reasonable, the software will turn on a continuous two-tone audible alarm and stop all drug delivery.



## Additional Technical Information

### Medfusion® Standard Syringes

Below is a table of the standard model syringes supplied with PharmGuard® Toolbox 2 (and included in the Medfusion® Standard Configuration) which can be used with the Medfusion® Model 3500 pump V6. (Information regarding syringe flow rate and minimum volume for these syringes can be found on the next page and in the product literature supplied with the syringe file.)

Model (Manufacturer)	Syringe Model/Sizes
<b>B-D® (Becton-Dickinson)</b>	1, 3, 5, 10, 20, 30 and 60 mL (Luer Lok™)
	1mL Slip tip (Tuberculin)
<b>Monoject® (Covidien)</b>	3, 6, 12, 20, 35 and 60 mL (Luer lock)
	1mL Slip tip (Tuberculin)
<b>Terumo® (Terumo® Medical)</b>	3, 5, 10, 20, 30 and 60mL (Luer Lock)
	1mL Slip tip (Tuberculin)
<b>BB Omnifix™ (B. Braun)</b>	5, 10, 20 and 50 mL (Luer Lock)
<b>BB Perfusor® (B. Braun)</b>	20 and 50 mL (Luer Lock)

The critical volume (maximum) which could be infused in the event of a single point failure is 1/100th of the syringe size by volume.

### PharmGuard® Supported Syringes (PSS) Series 2

In order to offer customers a wide range of available syringe manufacturers and sizes, Smiths Medical has available PharmGuard® Supported Syringes (PSS) Series 2 in addition to the Medfusion® Standard Syringes. Refer to [www.smiths-medical.com](http://www.smiths-medical.com) or call Customer Service for more information about available PharmGuard® Supported Syringes (PSS) Series 2.

The PharmGuard® Supported Syringes (PSS) Series 2 can only be imported into the PharmGuard® Toolbox 2. These additional syringe models can be sent to a pump as available syringes for the downloadable Configurations. (Information regarding syringe flow rate and minimum volume for these syringes can be found in the product literature supplied with the PSS Series 2.)

## Flow rate & minimum volume by manufacturer & size - Standard syringes

For flow rate and minimum volume information regarding syringes available in the PharmGuard® Supported Syringes (PSS) Series 2, see the product literature provided with that product. Please see the tables below for information regarding the lowest *recommended* rates for each syringe size used on the pump.

The table below is provided for convenience. Should changes to the listed syringes occur, the values shown here may be superseded (see the *Instructions for Use* provided with the Medfusion® Standard Syringes, Series 2.)

Model (Manufacturer)	Size mL	Min. Rate mL/hr	Max. Rate mL/hr	Minimum volume to infuse mL	Minimum recommended rate mL/hr	
					FlowSentry™ disabled	FlowSentry™ enabled
<b>B-D® (Becton-Dickinson)</b>						
<i>Tuberculin (Slip Tip)</i>	1	0.01	29	0.0016	0.033	N/A*
<i>Luer Lok™</i>	1	0.01	29	0.0016	0.033	N/A*
	3	0.01	98	0.005	0.1	0.03
	5	0.03	191	0.0083	0.17	0.05
	10	0.05	277	0.0166	0.33	0.1
	20	0.1	483	0.0333	0.67	0.2
	30	0.1	622	0.05	1	0.3
	60	0.1	944	0.1	2	0.6
<b>Monoject® (Covidien)</b>						
<i>Tuberculin (Slip Tip)</i>	1	0.01	29	0.0016	0.033	N/A*
<i>Luer Lock</i>	3	0.01	105	0.005	0.1	0.03
	6	0.03	213	0.01	0.2	0.06
	12	0.05	325	0.02	0.4	0.12
	20	0.1	536	0.0333	0.67	0.2
	35	0.1	735	0.0583	1.2	0.35
	60	0.1	944	0.1	2	0.6
<b>Terumo® (Terumo® Medical)</b>						
<i>Tuberculin (Slip Tip)</i>	1	0.01	29	0.0016	0.033	N/A*
<i>Luer Lock</i>	3	0.01	106	0.005	0.1	N/A*
	5	0.03	225	0.0083	0.17	N/A*
	10	0.05	333	0.0166	0.33	N/A*
	20	0.1	541	0.0333	0.67	N/A*
	30	0.1	712	0.05	1	N/A*
	60	0.11	1130	0.1	2	N/A*

Model (Manufacturer)	Size	Min. Rate	Max. Rate	Minimum volume to infuse	Minimum recommended rate	
	mL	mL/hr	mL/hr	mL	mL/hr	
<b>BB Perfusor® (B. Braun)</b>						
<i>Luer Lock</i>	20	0.1	481	0.0333	0.67	0.2
	50	0.1	1042	0.0833	1.7	0.5
<b>BB Omnifix™ (B. Braun)</b>						
<i>Luer Lock</i>	5	0.03	207	0.0083	0.17	0.05
	10	0.05	338	0.0166	0.33	0.1
	20	0.1	537	0.0333	0.67	0.2
	50	0.1	1042	0.0833	1.7	0.5

\*FlowSentry™ pressure monitoring is not available with 1 mL and Terumo® syringes.

Syringe Size	Minimum Recommended Bolus Volume
1mL	0.1mL
3mL	0.3mL
5mL	0.5mL
6mL	0.6mL
10mL	1mL
12mL	1mL
20mL	1mL
30mL	1mL
35mL	1mL
50mL	1mL
60mL	1mL

**WARNING:** Use the smallest syringe size necessary to deliver the fluid or medication. Using a large syringe at very low rates (below Minimum Recommended Rate for the syringe) may cause improper pump operation, delayed occlusion sensing, larger post occlusion bolus at higher occlusion limit settings, delivery inaccuracies, or other potential hazards. **Bolus Volume:** Delivering a bolus volume less than the recommended bolus volume for the syringe used may result in delivery inaccuracies. Use an infusion set with the smallest diameter tubing available that does not result in excessive back pressure at the desired flow rate. Consider priming, loading, bolus, and flush rates when selecting an infusion set.

Per the US Food and Drug Administration, the 28 syringes available as the general configuration for the Medfusion® Model 3500 pump V6 were tested

for stability with Morphine Sulfate, Dopamine and Floxuridine for Injection, USP as medications representative of drugs used for the routes of administration specified for use with the Medfusion® Model 3500 pump V6. The testing demonstrated that the pump had no adverse affect on the syringes and the medications contained within.

Other medications may be suitable for use with the syringes referenced for use with the Medfusion® Model 3500 pump V6. Before using different medications, refer to the FDA approved labeling by the drug manufacturer and syringe manufacturer, FDA requirements and your facility's established protocols and procedures for determining the suitability and compatibility of a desired medication for use with the syringes listed for use with the Medfusion® Model 3500 pump V6.

Prior to using a syringe for a route of administration, ensure that the syringe used meets the requirements for sterility and pyrogenicity for the desired route of administration.

## Concentration and dosing units

Drug Delivery Units					
Concentration Units	Delivery Units	/Time	/Min	/Hr	/Day
Millimoles	Millimoles	✓	✓	✓	✓
Milliequivalents	Milliequivalents	✓	✓	✓	✓
Units	Units	✓	✓	✓	✓
	Milliunits	✓	✓	✓	✓
Grams	Grams	✓	✓	✓	✓
	Milligrams	✓	✓	✓	✓
Milligrams	Milligrams	✓	✓	✓	✓
	Micrograms	✓	✓	✓	✓
Micrograms	Micrograms	✓	✓	✓	✓
	Nanograms	✓	✓	✓	✓

## PharmGuard® software limits

PharmGuard® software limits			
Delivery Mode	Parameter	Limit Type	Limit Range
mL/hr	mL/hr rate	Hard and Soft	User Defined
Volume / Time	Volume	Hard and Soft	User Defined
	Time	Hard and Soft	User Defined
Intermittent Volume / Time	Volume	Hard and Soft	User Defined
	Time	Hard and Soft	User Defined
	Time Between Starts	Hard and Soft	User Defined
Dose / Time	Concentration	Hard and Soft	User Defined
	Dose	Hard and Soft	User Defined
	Time	Hard and Soft	User Defines
Dose / Kg/ Time	Concentration	Hard and Soft	User Defined
	Body Weight	Configurable	User Defined
	Dose	Hard and Soft	User Defined
	Time	Hard and Soft	User Defined
mL / Kg/ Time	Body Weight	Hard MAX, Soft High Limit (Low and MIN cannot be set)	User Defined
	Volume / kg	Hard and Soft	User Defined
	Time	Hard and Soft	User Defined
Dose / m <sup>2</sup> / Time	Concentration	Hard and Soft	User Defined
	m <sup>2</sup>	Configurable	User Defined
	Dose	Hard and Soft	User Defined
	Time	Hard and Soft	User Defined

PharmGuard® software limits			
Delivery Mode	Parameter	Limit Type	Limit Range
<b>Dose / Hr</b> <b>Dose / Min</b> <b>Dose / Day</b>	Concentration	Hard and Soft	User Defined
	Dose	Hard and Soft	User Defined
<b>Dose / Kg / Hr</b> <b>Dose / Kg / Min</b> <b>Dose / Kg / Day</b>	Concentration	Hard and Soft	User Defined
	Body weight	Configurable	User Defined
	Dose rate	Hard and Soft	User Defined
<b>mL / Kg / Hr</b> <b>mL / Kg / Min</b>	Body Weight	Hard and Soft	User Defined
	Volume / kg	Hard and Soft	User Defined
<b>Dose / m<sup>2</sup> / Hr</b> <b>Dose / m<sup>2</sup> / Min</b> <b>Dose / m<sup>2</sup> / Day</b>	Concentration	Hard and Soft	User Defined
	m <sup>2</sup>	Configurable	User Defined
	Dose rate	Hard and Soft	User Defined
Options	Parameter	Limit Type	Limit range
<b>Loading dose</b>	Dose	Hard and Soft	User Defined
	Time	Hard and Soft	User Defined
<b>Bolus dose</b>	Dose	Hard and Soft	User Defined
	Time	Hard and Soft	User Defined
<b>KVO</b>	Rate	Hard	User Defined
	Volume	Hard MAX	
<b>Max bolus rate</b>	Rate	Hard	User Defined

## Configuration options

A pump's *Alarm Setup, Auto Prompts, Limits, Occlusion Detection* settings and many miscellaneous properties can be customized within the PharmGuard® Toolbox 2 software. These properties define the limits imposed by a pump and the general operational behavior of a pump. The following is a list of user configurable settings that are available. Each of these settings is customizable for each profile that is defined.

### General Options

General Options are optional settings that affect *all* infusions initiated in the defined profile.

- Alarm Loudness* Defines the loudness level of a pump's alarm. Select from five levels—*Level 1 (softest), Level 2, Level 3, Level 4, or Level 5 (loudest)*. The alarm cannot be disabled or completely silenced.
- Alarm Silence Time* Defines the number of minutes until the User Callback alarm will sound. Alarm Silence Time is a numeric value in the range 1 to 2 minutes.
- Alarm Style* Defines the tone style a pump will use when sounding an alarm. Select from three styles—*Medfusion® Defined, International Standard and Medfusion® Multi-tone*.

<i>Auto Lock Time</i>	Defines the number of seconds the pump will wait before automatically locking the pump's interface. Auto Lock Time is a numeric value in the range of 0 to 999 seconds. Setting this value to zero (0) or <i>(none)</i> will disable the <i>Auto Lock</i> feature.
<i>Bolus Change in mL</i>	Defines if a pump user can change a <i>Bolus Dose</i> or <i>Loading Dose</i> in mL. Select from two values— <i>Enabled</i> or <i>Disabled</i> .
<i>Bolus Time Feature</i>	Defines if a pump user will need to enter a time when setting a <i>Bolus Dose</i> in a manual delivery mode. <b>Due to a conflict between Drug Program and Profile options, bolus time is always enabled in Drug Programs.</b> Select from two values— <i>Enabled</i> or <i>Disabled</i> .
<i>Bolus Total Dose</i>	Defines if a pump user will be allowed to enter a Bolus Dose or Loading Dose as a Total Dose rather than the standard dose/kg in weight based modes. Select from two values— <i>Enabled</i> and <i>Disabled</i> .
<i>Date Separator</i>	Defines whether dates are separated by a slash (yyyy/mm/dd) or a dash (yyyy-mm-dd).
<i>Decimal Separator</i>	Defines whether decimal points in numbers are represented by a comma or a period.
<i>Enter User ID on Override</i>	Defines if the pump will prompt a user for their <i>User ID</i> when overriding a Drug Program infusion property. Select from two values— <i>Enabled</i> or <i>Disabled</i> .
<i>Flush</i>	Defines if the Flush features will be available on the pump. Select from two values— <i>Enabled</i> or <i>disabled</i> .
<i>Flush Time</i>	Defines if a user will be prompted to enter a flush time when programming a flush infusion. Select from two values— <i>Enabled</i> or <i>disabled</i> .
<i>Maximum Flush Volume</i>	Defines the maximum flush volume (in mL) allowed by the pump during a flush infusion. Maximum flush volume is a numeric value from the minimum volume for the syringe to the fill volume of the syringe.
<i>FlowSentry™</i>	Defines if the FlowSentry™ pressure monitoring (for rapid occlusion detection) feature is enabled. Select from two values— <i>Enabled</i> or <i>Disabled</i> .
<i>FlowSentry™ Sensitivity</i>	Defines the sensitivity of the FlowSentry™ pressure monitoring algorithm during normal infusion. Select from four values— <i>Low - least sensitive</i> , <i>Normal</i> , <i>High</i> , or <i>Very High - most sensitive</i> .
<i>FlowSentry™ Startup Sensitivity</i>	Defines the sensitivity of the FlowSentry™ pressure monitoring algorithm during infusion startup. Select from four values— <i>Low - least sensitive</i> , <i>Normal</i> , <i>High</i> , or <i>Very High - most sensitive</i> .
<i>Key Click (key click loudness)</i>	Defines the click loudness level when pressing pump keys. Select from five levels— <i>Off</i> , <i>Level 2</i> , <i>Level 3</i> , <i>Level 4</i> , or <i>Level 5</i> (Level 5 is the loudest).
<i>Maximum Body Surface Area</i>	Defines the maximum allowed value for the <i>Body Surface Area</i> infusion parameter. Maximum Body Surface Area is a numeric value in the range of 0.01 to 4 m <sup>2</sup> .
<i>Maximum Bolus Rate</i>	Defines the <b>maximum</b> bolus infusion rate allowed by the pump. Select from three rates— <i>Syringe Size x 5 mL/hr</i> (example: 5 mL syringe × 5 mL/hr = 25 mL/hr maximum bolus rate), <i>Syringe Size x 10 mL/hr</i> (example: 5 mL syringe



× 10 mL/hr = 50 mL/hr maximum bolus rate), or *Syringe Size Max mL/hr* (see the table on page 129).

<i>Maximum Flow Rate</i>	Defines the maximum flow rate allowed by the pump. Maximum Flow Rate is a numeric value in the range 0.1 to 1130 mL/hr, and is dependent on the syringe size being used.
<i>Maximum Patient Weight</i>	Defines the maximum allowed value for the <i>Patient Weight</i> infusion parameter. Maximum Patient Weight is a numeric value in the range 0.25 to 250 kg.
<i>Near Empty Time</i>	Defines the number of minutes remaining before a syringe is empty, at which time a <i>Syringe Near Empty Alarm</i> will occur. Near Empty Alarm Time is a numeric value in the range 0 to 240 minutes. Setting this value to zero will disable the <i>Syringe Near Empty Alarm</i> .
<i>Near Empty Alarm Priority</i>	Defines the priority level at which to generate the <i>Syringe Near Empty Alarm</i> . Select from two levels— <i>Low</i> or <i>Medium</i> .
<i>Occlusion Limit</i>	Defines the pressure at which the pump will consider the line occluded. Select from four limits— <i>Very Low</i> (Approx. 4 psi, 206.9 mmHg), <i>Low</i> (Approx. 8 psi, 413.7 mmHg), <i>Normal</i> (Approx. 12 psi, 620.6 mmHg), and <i>High</i> (Approx. 16 psi, 827.4 mmHg). For 1 mL syringes, the occlusion limit is fixed at <i>Very High</i> (Approx. 50 psi) and cannot be changed.
<i>Profile Passcode</i>	Allows setting a <i>four-digit passcode</i> which the user must enter to access the Profile. Profile Passcodes can be any numeric code in the range of 1000 to 9999. If set to ( <i>none</i> ), no passcode is required to access the Profile.
<i>Program Display</i>	Defines if the pump will display the delivered <i>Program Dose</i> or the delivered <i>Program Volume</i> . Select from two values: <i>Volume</i> or <i>Dose</i> .
<i>Quick Library</i>	Defines the Library Category that will be used as the Quick Library.
<i>Syringe 1mL Support</i>	Defines if 1 mL syringe support is enabled, allowing the use of 1 mL syringes. Select from two values— <i>Enabled</i> or <i>Disabled</i> .
<i>Unlock Passcode</i>	Defines the passcode that must be entered at a pump to unlock its interface. Unlock Passcodes can be any four-digit numeric code in the range 1000 to 9999. If set to ( <i>none</i> ), no passcode is required to unlock the pump.

## Auto Prompt Options

Auto Prompt Options are optional settings that the user will be prompted to enter for all infusions initiated in the defined profile. The default for all Auto Prompt Options is Disabled.

<i>Bolus Dose</i>	Defines if a pump user will be prompted to enter a <i>Bolus Dose</i> during infusion setup. Select from two values— <i>Enabled</i> or <i>Disabled</i> .
<i>Confirm Settings</i>	Defines if a pump user will be prompted to <i>Confirm Infusion Settings</i> when setting up an infusion. Once the infusion settings are made, if Confirm Settings is enabled the user will be required to re-confirm the settings. Select from two values— <i>Enabled</i> or <i>Disabled</i> .
<i>Enter User ID to Program</i>	Defines if a pump user will be prompted to enter their <i>User ID</i> when programming an infusion. Select from two values— <i>Enabled</i> or <i>Disabled</i> .

<i>Prompt to Prime</i>	Defines if a pump user will be prompted to <i>Prime</i> as a last step in setting up an infusion. Select from two values— <i>Enabled</i> or <i>Disabled</i> .
<i>Re-enter Weight</i>	Defines if a pump user will be prompted to re-enter a patient's weight to confirm the setting (a double check). Select from two values— <i>Enabled</i> or <i>Disabled</i> .
<i>Standby Time</i>	Defines if a pump user will be prompted to enter a <i>Standby</i> time during infusion setup. Select from two values— <i>Enabled</i> or <i>Disabled</i> .
<i>Volume Limit</i>	Defines if a pump user will be prompted to enter a <i>Volume Limit</i> during infusion setup. Select from two values— <i>Enabled</i> or <i>Disabled</i> .

## Program Options

Program Options are optional settings that affect the **current** infusion initiated in the defined profile. While individual options can be enabled for a profile, they can also be disabled in individual drug programs within that profile. Settings in drug programs take priority over those of the profile.

<i>Bolus Dose</i>	Defines if a pump user will be able to enter a <i>Bolus Dose</i> during infusion setup.
<i>Delayed Start</i>	Defines if a pump user will be able to enter a <i>Delayed Start</i> time during infusion setup. The range is 0 to 6 hours.
<i>KVO</i>	Defines if a pump user will be able to enter a Keep-Vein-Open (KVO) rate. This value cannot be set or changed while an infusion is running.
<i>Loading Dose</i>	Defines if a pump user will be able to enter a <i>Loading Dose</i> during infusion setup.
<i>Override Alarm Loudness</i>	Defines if a pump user will be able to change the loudness level of a pump's alarm during an infusion.
<i>Override Occlusion Limit</i>	Defines if a pump user will be able to override the profile default setting of the pressure at which the pump will consider the line occluded for the current infusion.
<i>Periodic Callback Alarm</i>	Defines if a pump user will be able to enter a <i>Periodic Callback Alarm</i> time during infusion setup. The range is 0 to 8 hours.
<i>Standby</i>	Defines if a pump user will be able to enter a <i>Standby</i> time during infusion setup. The range is 0 to 24 hours.
<i>Toggle Vol Empty Tone</i>	Defines if a pump user will be able to enable the <i>Syringe Vol Empty Alarm Tone</i> for the <b>current</b> infusion.
<i>Toggle FlowSentry™</i>	Defines if a pump user will be able to disable the <i>FlowSentry™</i> pressure monitor (for rapid occlusion detection) feature for the current infusion.
<i>Toggle Near Empty Tone</i>	Defines if a pump user will be able to disable the <i>Syringe Near Empty Alarm Tone</i> for the <b>current</b> infusion.
<i>Toggle PVD/PDD</i>	Displayed on the pump options menu as “Change to Dose” or “Change to Volume.” Defines if a pump user will be able to change the profile default setting to display the delivered <i>Program Dose</i> or the delivered <i>Program Volume</i> .



## *Volume Limit*

Defines if a pump user will be able to enter a *Volume Limit* during infusion setup. This value cannot be set or changed while an infusion is running. The range is 0 to 500 mL.

## Device Setup Features

The following items are set on a per pump basis in the Device Setup menu. While these features do not directly affect infusion programming, they can affect alarms and reporting.

### *Serial Number*

Displays the pump serial number.

### *Preventative maintenance date*

Defines the date when the pump's preventative maintenance required alarm activates.

### *Time Zone*

Defines the time zone where the pump is located.

### *Daylight Saving*

Defines if a pump will automatically switch to Daylight Saving Time on the appropriate date. If selected, specify when Daylight Saving begins and ends, what time the clocks change, and by how much.

---

## Flow Delivery Graphs

In this device, as with all syringe infusion pumps, the motion of the pumping mechanism and variations in individual disposables (both the syringe and infusion set) cause short-term fluctuations in the rate accuracy. The curves on the following page show typical performance of the pump system in two ways:

1. A flow versus time graph during the stabilization period (start-up curves).
2. The accuracy of fluid delivery of particular time periods or 'observation windows' is measured (trumpet curves).

The start-up curve displays flow rate continuously from the start of the infusion. The curve visually represents flow rate uniformity. Trumpet curves are derived from the second hour of this data. Tests were performed per the IEC 60601-2-24 standard.

Over long observation windows, short term fluctuations have minimal effect on accuracy as represented by the flat part of the curve. As the observation window is reduced, short term fluctuations have an increasing effect as represented by the "mouth" of the trumpet. Being aware of system accuracy over various observation windows may be of interest when certain drugs are being administered. Short term fluctuations in rate accuracy may have

clinical impact depending on the half-life of the drug being infused, therefore both the trumpet curve and drug half-life should be taken into account.

The data was created using a Medfusion® pump and Becton-Dickinson (B-D®) WWD 30 mL syringe. The 1 mL/hr data was created using the Medfusion® 536040 Extension set and 18G needle. The 5 mL/hr data was created using the Medfusion® MX448HL60 Extension set and 18G needle.

**Start-up curves over stabilization period**

Minimum rate (1 mL/hr)

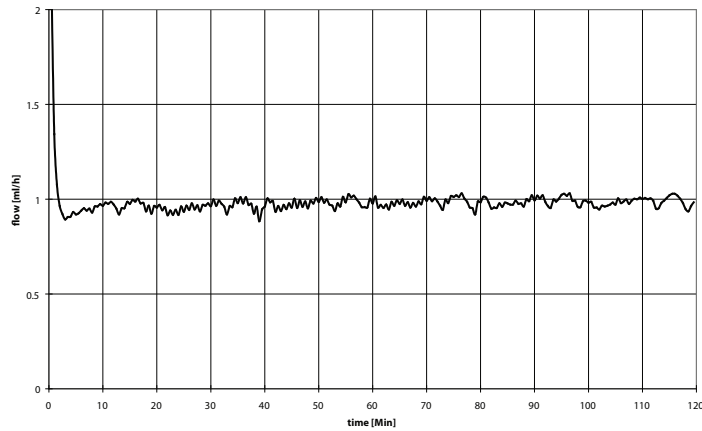

Intermediate rate (5 mL/hr)

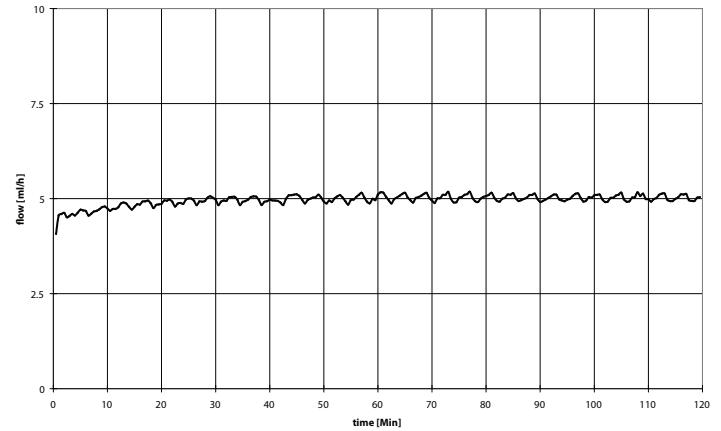

**Trumpet curves over T2 period**

Minimum rate (1 mL/hr)

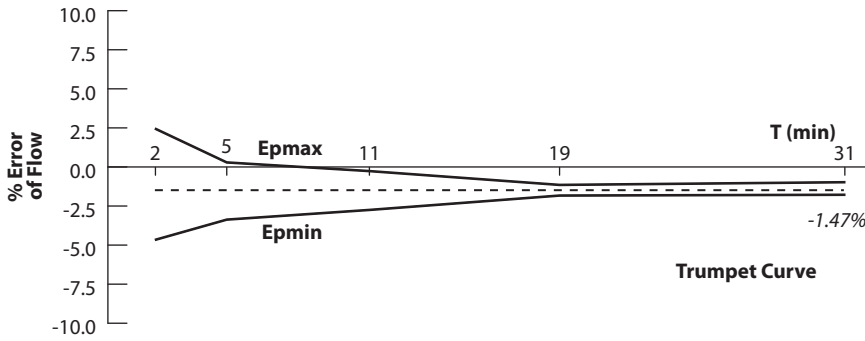

Intermediate rate (5 mL/hr)

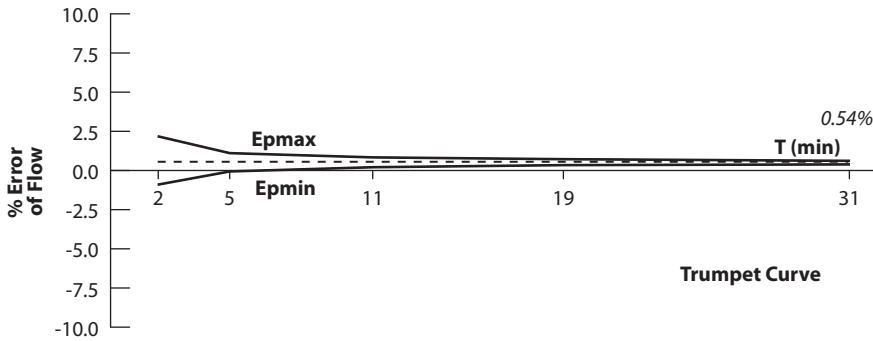

## Magnetic Resonance Imaging (MRI) Information

The Medfusion® Model 3500 pump V6 is MR Conditional according to the terminology specified in ASTM F2503-08, Standard Practice for Marking Medical Devices and Other Items for Safety in the Magnetic Resonance Environment.

Non-clinical testing demonstrated that the Medfusion® Model 3500 pump V6 is MR Conditional. The pump will not present a hazard or risk to the patient or MR user, or significantly affect the MR image quality if the pump is operated according to the specific guidelines as follows:

---

**WARNING:** The pump must be positioned in an MR environment such that it is ***secured to a non-moveable object*** and the magnetic fringe field ***does not exceed 150 gauss***. Exposing the Medfusion® Model 3500 pump V6 to magnetic fields that exceed 150 gauss presents a risk of becoming a projectile hazard and can lead to possible patient injury or death. Irreversible damage to the pump can also occur, rendering it inoperable.

---

### MRI Related Testing

In non-clinical testing, the Medfusion® Model 3500 pump V6 evaluations have included Magnetic Attraction (projectile hazard), MR interference with the pump, and MR Image Distortion.

- Magnetic Attraction (projectile hazard): The Medfusion® Model 3500 pump V6 showed no attraction torque or force at 150 gauss static magnetic field strength.
- MR Interference with the Pump: The Medfusion® Model 3500 pump V6 operated normally while in the 150 gauss static magnetic field.
- MR Image Distortion: No MR imaging interference was observed when tested with the Medfusion® Model 3500 pump V6 at 8 feet from the isocenter of a 1.5T (64 MHz) Siemens Symphony MR system, Siemens Software 2002 Revision C, under the following conditions: battery only (no AC cord), back of the pump facing the MRI isocenter, full body receiver coil (most sensitive), using standard spin echo, fast spin echo and gradient spin echo pulse sequences.

## Image Distortion

Certain MRI receiver coils are sensitive to electronic emissions. Therefore, prior to patient examinations, MR image scans should be completed while operating the Medfusion® Model 3500 pump V6 in the MR environment that is to be used for the examination to verify acceptable MR image quality. Note that results vary between MRI systems due to differences in scanning systems and receivers used.

The following are tips to minimize the possibility of image artifacts appearing:

- Ensure that the back of the pump faces the MRI isocenter during operation (pump screen facing away from the MRI).
- Move the pump further from the isocenter of the MRI system if image artifacts appear.
- Operate the Medfusion® Model 3500 pump V6 on battery power in an MR environment. The presence of a powered AC cord typically induces image artifacts.

Furthermore, the MRI technologist can improve the Signal to Noise Ratio (SNR) of the image, typically reducing or eliminating image artifacts, by adjusting any of the following variables:

- Use signal rich pulse sequences like Spin Echo where applicable
- Decrease the Phase Encoding matrix
- Increase the acquisition Field of View
- Increase the slice thickness
- Increase the number of averages

## Cleaning and care

Below are common methods and cautions relating to cleaning and caring for the infusion pump.

---

**WARNING: Power Source:** To avoid electric shock, before cleaning, always switch electrically operated equipment off and disconnect from AC power source.

---

### CAUTIONS:

- **DO NOT USE** cleaning solutions containing: *acetone, ammonia, ammonium chloride* (including Hyamine 1622), *aromatic solvents* (such as paint thinner, toluene, methylbenzene), *chlorinated solvents* (such as methyl ethyl ketone (MEK), trichloroethane), *ether* (such as ethylene glycol monobutyl ether, diethylene glycol butyl ether) or *oxidizing acids* (such as phosphoric acid, sulfuric acid or accelerated hydrogen peroxide).

Use of the solutions or solvents listed as DO NOT USE could damage plastic parts and cause premature failure or device malfunction.

- **Use only the recommended cleaning/disinfecting agents and method.** Use of cleaning/disinfecting agents and method other than those listed may cause damage to the pump and will void the warranty.
  - **Spray Resistant:** The pump is “spray resistant” from the top and sides but not “water proof”. **NEVER** spray cleaning or other fluids directly into openings on the bottom of the pump.
  - **Not Waterproof:** The pump is not certified “water proof”. Never immerse the pump in water or other fluids.
  - **Avoid Oil Sprays:** **NEVER** use light oil sprays (e.g., WD40®) to clean or lubricate pump. These oils contain chemicals that can damage the plastic of the pump. No *user-added* lubrication is necessary.
  - **Never Autoclave:** **NEVER** sterilize the pump in a steam autoclave or gas. Using autoclave or gas sterilization can seriously damage the infusion pump and void the warranty.
- 

1. The following agents have been tested and can be used to safely clean the syringe pump without damaging the pump housing when the procedure listed in item 2, below, is used:
  - Isopropyl alcohol 70% solution
  - Household bleach (Sodium Hypochlorite), (6% solution diluted to 1:6) or 1.0%
  - Sani-Cloth® Bleach by PDI
  - Mild detergent mixed with water (has no disinfection properties)
2. Clean by spraying cleaning agent directly onto a soft cloth (or use wipes/cloths listed) and wipe pump, then wipe surfaces dry. Never allow cleaning agents to pool on the device as prolonged contact could damage the pump and its components.

## Maintenance & service

This chapter includes information relating to both standard maintenance and service.

---

### WARNINGS:

- **Pump Maintenance.** To avoid electric shock, only trained biomedical service personnel may service this pump. Service personnel should disconnect the AC power cord before servicing the pump.
  - **Shock Hazard:** The only means of removing AC power is to disconnect the AC power cord. While the AC power cord is attached to the pump and plugged into an AC outlet, live main voltage is present within the pump.
  - **Manufacturer Recommended Maintenance:** Always maintain this pump following *manufacturer recommended instructions* in the *Technical Service Manual*. Improperly maintained pumps may cause either under-infusion or over-infusion to patient.
  - **Never Open the Pump Case:** To avoid electric shock, users should never open the pump case or battery compartment for any reason. Service personnel should always disconnect the AC power cord before servicing the pump.
  - **Dropped or Damaged Pumps:** Never use a dropped or obviously damaged pump. Withdraw it from service until a trained biomedical technician can test it.
- 

## Periodic maintenance

Trained biomedical service personnel should test the pump at least yearly to ensure continued safe operation.

- This testing should be performed at least yearly, or whenever the pump has been damaged or dropped.
- The *occlusion* and *other sensors* must be checked yearly.
- Refer to the *Technical Service Manual* for specific details.

The *PharmGuard® Toolbox 2 User's Manual* (provided with the PharmGuard® Toolbox 2 software) provides information on customizing the settings and features of the pump, which in turn affect the use and operation of the pump on a daily basis.

The *Medfusion® Model 3000 Series Technical Service Manual*, (catalog number G6000278) provides technical information on this pump, including:

- Functional Descriptions
- Calibration
- Pump teaching, learning, cloning
- Theory of Operation
- Diagnosis and Testing
- Service Parts\*

Contact Smiths Medical for availability.

\*Including replacement battery packs and power cords

## Using Smiths Medical USA service assistance

Use the following steps to make use of Smiths Medical USA service assistance:

1. Contact the Smiths Medical Service Department (USA) at one of the following telephone numbers:

<b>Toll-free in the U.S.</b>	1 800.258.5361
<b>Outside the U.S.</b>	1 214.618.0218

2. When calling any of these numbers, please have the following ready:
  - Model name / number of pump
  - Pump serial number
  - Purchase date if pump is within warranty period
  - Description of problem in as much detail as possible
3. The service representative may “talk you through” to a solution if possible.

Component parts such as the internal battery can be ordered from Smiths Medical Service and Repair.

---

**Note:** If outside the USA, contact your local distributor for service assistance.

---

## Returning a pump to the USA for repair

When the service representative cannot resolve an issue over the phone, then it becomes necessary to return the infusion pump for service.

1. If the problem cannot be resolved through the telephone assistance of the Service Department, obtain a Return Authorization (RA) number by calling Customer Service at 1 800.258.5361 (USA). Customer Service hours of operation are Monday through Friday, 7:00AM to 5:30PM CST.
2. Clean and decontaminate the pump and accessories prior to returning items to Smiths Medical. This is required before shipment according to United States Occupational Safety & Health Administration (OSHA) regulations.
3. Package the infusion pump carefully for shipment.
4. Smiths Medical will not accept returns for service without the assigned RA number clearly printed on the shipping package. Mark the RA number clearly on the outside of the shipping package used to return the pump.
5. Ship the carefully packaged infusion pump to:

Smiths Medical ASD, Inc.  
1265 Grey Fox Road  
St. Paul, MN 55112  
1 800.258.5361 (USA)  
www.smiths-medical.com

---

**Note:** Unless accessory items (such as the poleclamp, AC power cord, etc.) are specifically part of the problem encountered, remove all accessory items from the pump before returning it to Smiths Medical.

---



## **Collect Separately**

---

---

**WARNING: *Collect Separately.*** There are potential health hazards associated with improper disposal of batteries, electronics, and contaminated (used) infusion sets and syringes. Dispose of used batteries, infusion sets, syringes, and other used accessories, or a pump that has reached the end of its useful life, in an environmentally safe manner, and according to any regulations that may apply.

---

---

This product contains electrical and electronic components (including batteries) that may contain materials which, if disposed of with general waste, could be damaging to the environment.

In accordance with Directive 2002/96/EC Waste Electrical and Electronic Equipment, residents of the European Union must follow specific disposal or recycling instructions for this product. Contact your local distributor, or visit the following web site for specific instructions:

<http://www.smiths-medical.com/recycle/index.html>

Non-European Union residents must dispose of or recycle this product (including batteries) in accordance with the local laws or regulations that apply.

## Limited Warranty

Smiths Medical ASD, Inc. (the “Manufacturer”) warrants to the Original Purchaser that the Medfusion® Syringe Pump Model 3500 V6 (the “Pump”), not including accessories, shall be free from defects in materials and workmanship under normal use, if used in accordance with this Operator’s Manual, for a period of one (1) year from the actual date of sale to the Original Purchaser. THERE ARE NO OTHER WARRANTIES.

This warranty does not cover normal wear and tear and maintenance items, and specifically excludes batteries, administration sets, extension sets or any other accessory items or equipment used with the Pump.

Subject to the conditions of and upon compliance with this Limited Warranty, the Manufacturer will repair or replace at its option without charge (except for a minimal charge for postage and handling) any Pump (not including accessories) which is defective if a claim is made during such one-year period.

The following conditions, procedures, and limitations apply to the Manufacturer’s obligation under this warranty:

**A. Parties Covered by this Warranty:** This warranty extends only to the Original Purchaser of the Pump. This warranty does not extend to subsequent purchasers. The Original Purchaser may be a patient, medical personnel, a hospital, or institution which purchases the Pump for treatment of patients. The Original Purchaser should retain the invoice or sales receipt as proof as to the actual date of purchase.

**B. Warranty Performance Procedure:** Notice of the claimed defect must be made in writing or by telephone to the Manufacturer as follows: Customer Service Department, **Smiths Medical ASD, Inc.**, 1265 Grey Fox Road, St. Paul, MN 55112 USA, 1 800.258.5361 (USA) . Notice to the Manufacturer must include date of purchase, model and serial number, and a description of the claimed defect in sufficient detail to allow the Manufacturer to determine and facilitate any repairs which may be necessary. **AUTHORIZATION MUST BE OBTAINED PRIOR TO RETURNING THE PUMP.** If authorized, the Pump must be properly and carefully packaged and returned to the Manufacturer, postage prepaid. Any loss or damage during shipment is at the risk of the sender.

**C. Conditions of Warranty:** The warranty is void if the Pump has been 1) repaired by someone other than the Manufacturer or its authorized agent; 2) altered so that its stability or reliability is affected (which includes use of service/replacement parts not supplied by Smiths Medical or its authorized agents, including the battery pack); 3) misused; or, 4) damaged by negligence or accident. Misuse includes, but is not limited to, use not in compliance with the Operator’s Manual or use with non-approved accessories. Removal or damage to the Pump’s serial number will invalidate this warranty.

**D. Limitations and Exclusions:** Repair or replacement of the Pump or any component part thereof is the **EXCLUSIVE** remedy offered by the Manufacturer. The following exclusions and limitations shall apply:

1. No agent, representative, or employee of the Manufacturer has authority to bind the Manufacturer to any representation or warranty, expressed or implied.

2. THERE IS NO WARRANTY OF MERCHANTABILITY OR FITNESS OR USE OF THE PUMP FOR ANY PARTICULAR PURPOSE.

3. The Pump can only be used under the supervision of medical personnel whose skill and judgment determine the suitability of the Pump for any particular medical treatment.

4. All recommendations, information, and descriptive literature supplied by the Manufacturer or its agents are believed to be accurate and reliable, but do not constitute warranties.

**E. Computer Program License:**

1. The Pump is intended to be used in conjunction with a particular Licensed Computer Program supplied by Manufacturer and use of any other program or unauthorized modification of a Licensed Computer Program shall void Manufacturer’s warranty as set forth above.

2. The Original Purchaser and any users authorized by the Original Purchaser are hereby granted a nonexclusive, nontransferable license to use the Licensed Computer Program only in conjunction with the single Pump supplied by Manufacturer. The Licensed Computer Program is supplied only in machine-readable object code form and is based upon Manufacturer’s proprietary confidential information. No rights are granted under this license or otherwise to decompile, produce humanly readable copies of, reverse engineer, modify or create any derivative works based upon the Licensed Computer Program.

3. All other terms and conditions of this Limited Warranty shall apply to the Licensed Computer Program.

The Manufacturer disclaims responsibility for the suitability of the Pump for any particular medical treatment or for any medical complications resulting from the use of the Pump. The Manufacturer shall not be responsible for any incidental damages or consequential damages to property, loss of profits, or loss of use caused by any defect or malfunction of the Pump.

This warranty gives the Original Purchaser specific legal rights, and the Original Purchaser may have other legal rights which may vary from state to state.

# Index

## A

AC power connection port 7, 110  
 Alarms & alerts 99  
     Troubleshooting 103

## B

Battery 110  
     Battery Alarms 107  
     guidelines 111  
     Onscreen power gauge 111  
 Body weight/surface area infusions 44  
 Bolus dosing 60  
     Bolus rate reduction 64, 106  
     Continuing/restarting a bolus dose 63

## C

Changing rate 94  
     during delivery 94  
     when paused 95  
 Cleaning the pump 139  
 Concentration and dosing units 131  
 Configuration 5, 10, 132  
 Configuration profile 28  
 Continuing a bolus dose 63  
 Continuing a loading dose 69  
 Continuous mode: ml/hr 37

## D

Data Handling Software Safety Features 126  
 Delayed start 78, 87  
 Delivering a loading dose 68  
 Delivery mode 31  
 Display 7  
 Dose / Day 40  
 Dose / Hr 38  
 Dose / Min 38  
 Dose / Time 42

## E

ECMO (Extracorporeal Membrane Oxygenation) 6  
 Electromagnetic Compliance (EMC) 114  
 Explosion risk warning 1

## F

FlowSentry rapid occlusion detection 5, 92  
 Flush feature 88, 133

## G

General Use Diagram 21

## H

Hard limits 12, 17, 131  
 Hardware-related Software Safety Features 126  
 hyperbaric chamber use warning 1

## I

Intermittent volume / time 53

## K

Keep Vein Open (KVO) rate 74  
 Keypad 8  
     buttons (or keys) 9  
     Indicators 9  
 Keypad lock 98  
     Unlocking 98

## L

Libraries  
     Quick 13  
     Standard 13  
 Loading a syringe 32  
     Unloading a syringe 36  
 Loading dose 66  
     Continuing/restarting a loading dose 69  
     Delivering a loading dose 68  
     Loading dose rate reduction 70  
 Locking the keypad 98

## M

Maintenance & service 140  
 Mode 12, 31  
     Body weight/surface area infusions 44  
     Continuous 37  
     Dose / Day 40  
     Dose / Hr 38  
     Dose / Min 38  
     Dose / Time 42  
     Intermittent Volume / Time 53  
     Recall last settings 55  
     Volume / Time 52  
 MRI (Magnetic Resonance Imaging) 138

## N

Near empty alarm tone, disable/enable 84

**O**

- Occlusion settings 92
  - Post occlusion bolus reduction 93
- Options 59, 135
  - Bolus dosing 60
  - Delayed start 78, 87
  - Disable/enable near empty alarm tone 84
  - Disable/enable rapid occlusion detection 84
  - Disable/enable vol empty alarm tone 85
  - KVO (Keep Vein Open) 74
  - Loading dose 66
    - Delivering a loading dose 68
  - Override alarm loudness 83
  - Override occlusion limit 82
  - Periodic callback alarm 79
  - Standby 76
- Override alarm loudness 83
- Override occlusion limit 82

**P**

- Periodic callback alarm 79
- PharmGuard Safety Software 5, 13, 17, 29, 131
- Poleclamp 112
  - rotating/detachable poleclamp
    - Assembling 113
- Post occlusion bolus reduction 93
- Prime function 34, 55
- Program Dose Delivered (PDD) 96
  - Clearing 97
  - Displaying 96
- Program Volume Delivered (PVD) 96
  - Clearing 97
  - Displaying 96

**Q**

- Quick libraries 13

**R**

- Rapid occlusion detection, disable/enable 84
- Rate reduction 64, 70, 106
- Recall last settings 55
- Restarting a bolus dose 63
- Restarting a loading dose 69

**S**

- Self-tests 24
- Service 140
- Soft limits 12, 17, 131
- Software Safety Features 126
  - Data Handling Software Safety Features 126
  - Hardware-related Software Safety Features 126

- Standard libraries 13
  - Using 14
- Standby 76, 87
- Starting an infusion 86
  - from pause 86
  - from standby, delayed start 87
- Stopping an infusion 87
- Stopping delivery 87
- Symbols 4
- Syringe barrel clamp 7, 33, 34
- Syringe barrel flange clip 7, 33
- Syringe manufacturer/type 37
- Syringe plunger driver 7, 34
- Syringe plunger holders 7
- Syringe plunger release lever 7, 33, 34
- System Advisory 107
- System Failures 102, 108

**T**

- Technical specifications 122
  - Concentration and dosing units 131
  - Flow delivery graphs (trumpet curves) 136
  - Options 135
  - PharmGuard limits 131
- Total Volume Delivered 96
  - Clearing 97
- Trumpet curves (flow delivery graphs) 136
- Tubing holders 7, 35
- Turning the pump off 25

**U**

- Unloading a syringe 36
- Unlocking the keypad 98
- User Callback alarm 101

**V**

- Vol Empty alarm tone, disable/enable 85
- Volume / time - ml/hr infusions 52

**W**

- watchdog 126
- Workflow Process 21



**Smiths Medical ASD, Inc.**

1265 Grey Fox Road, St. Paul, MN 55112 USA

1 800.258.5361 (USA), 1 214.618.0218

[www.smiths-medical.com](http://www.smiths-medical.com)

**Rx  
ONLY**

Medfusion, PharmGuard, FlowSentry, and the Medfusion and Smiths Medical design marks are trademarks of Smiths Medical. The symbol ® indicates the trademark is registered in the U.S. Patent and Trademark Office and certain other countries. All other names and marks mentioned are the trade names, trademarks or service marks of their respective owners.

© 2013 Smiths Medical. All rights reserved.  
2013-04 40-6370-01A

**smiths medical**